

ANCHOR, MOORING, DOCKING & FENDERING 01

ANCHORS

Rocna Fisherman Anchor.....	1.02
Rocna Original Anchor	1.02
Rocna MKII Anchor	1.03
Rocna Vulcan Anchor.....	1.03
Fixed-Head Power Anchor	1.04
Claw Anchors	1.04 - 1.05
Delta-Style Slider Anchor	1.05
Ankerplex Folding Anchor	1.06
Ankerplex Stowage Bag.....	1.06
Bull Anchor	1.07
Sand Anchor (Danforth)	1.07
Sand Anchor and Rope Kits	1.07
Reef Anchor	1.08
Grapnel Folding Anchor	1.08
Grapnel Hook	1.08
Sea Anchors.....	1.08

CHAIN

Anchor Chain Claws.....	1.08
Swivels	1.09
Rope Shackle.....	1.09
Thimbles.....	1.10
D & Bow Shackles.....	1.10 - 1.11
Chain.....	1.12

ROPE

Lanyard	1.13
Dock Lines	1.13
Anchor Rope	1.13
Moorings Springers.....	1.14

HOOKS & FENDERS

Boat Hooks.....	1.14
Boat Fenders.....	1.15
Round Buoys.....	1.15
Fender Baskets	
Dock Fenders.....	1.16
Pontoon Fenders.....	1.17
Gunwale	1.17 - 1.20



Rocna Fisherman Anchors

A galvanised anchor for fishermen and divers on smaller boats that frequently re-anchor. It features a shackle rail for easier recovery of a fouled anchor.

- Easier retrieval in difficult conditions.
- For day trips rather than extended cruising.

Refer to table below for dimensions

Part No.	Anchor Size (kg)
JPW96200	4
JPW96201	6



Rocna Original Anchors

The Rocna is a true multi-purpose Super High Holding Power anchor that sets and holds in most seabeds, from soft mud to hard sand, clay, grass and kelp.

The roll-bar ensures that the anchor always arrives at the ideal angle for penetration, and the setting skids guide the fluke tip, which acts as a sharp chisel cutting into the seabed.

With a third of the anchor's weight on its fluke tip, an instant reliable set is ensured with every use.

- Extremely resistant to twisting and bending forces when the anchor is under load.
- Fits most bow rollers and suits vessels of all sizes.
- Stainless steel sizes: 4kg (9 lb) - 70kg (154 lb)
- Galvanised sizes: 4kg (9 lb) - 150kg (331 lb).

There's a Rocna Anchor to fit any size boat. Contact us for special order sizes.

Part No.		Anchor Size		Dimensions (mm)								Sugg. Boat Size (m)
Galvanised	Stainless Steel	(lb)	(kg)	A	B	C	D	E	F	G	Width	
JPW96204	JPW96218	9	4	547	234	154	133	96	103	75	275	4-6
JPW96205	JPW96219	13	6	630	270	170	150	102	123	80	315	5-8
JPW96206	JPW96220	22	10	724	312	204	174	130	133	90	365	7-11
JPW96207	JPW96221	33	15	830	360	235	205	145	156	100	415	8-12
JPW96208	JPW96222	44	20	864	373	244	220	162	158	110	435	9-14
JPW96209	JPW96223	55	25	971	420	275	233	175	184	115	485	10-16
JPW96210	JPW96224	73	33	1066	485	280	254	180	206	120	532	11-20
JPW96211	JPW96225	88	40	1142	520	300	278	188	224	130	570	14-22
JPW96212	JPW96226	121	55	1235	560	323	306	225	226	150	620	16-26
JPW96213	JPW96227	154	70	1338	607	354	330	240	250	155	670	18-28
JPW96214	-	243	110	1490	675	390	352	265	286	180	745	20-28
JPW96215	-	331	150	1725	779	449	416	318	317	203	867	-



Rocna MKII Anchors

After years of careful testing and refinement, the MKII is the first major improvement since the launch of the highly successful and acclaimed Rocna Original.

- The shank is further strengthened and brings higher resistance to bending.
- Improved setting performance and penetrates more easily to a deep and secure burial.
- Surer self-righting roll-bar provides extra assistance if the anchor lands upside-down and improves soil flow for reduced clogging.
- The weighted and reinforced fluke has been optimized for weight distribution, penetration, and strength.
- Fits most bow rollers and suits vessels of all sizes.
- Available in sizes: 4kg (9 lb) - 50kg (110 lb).

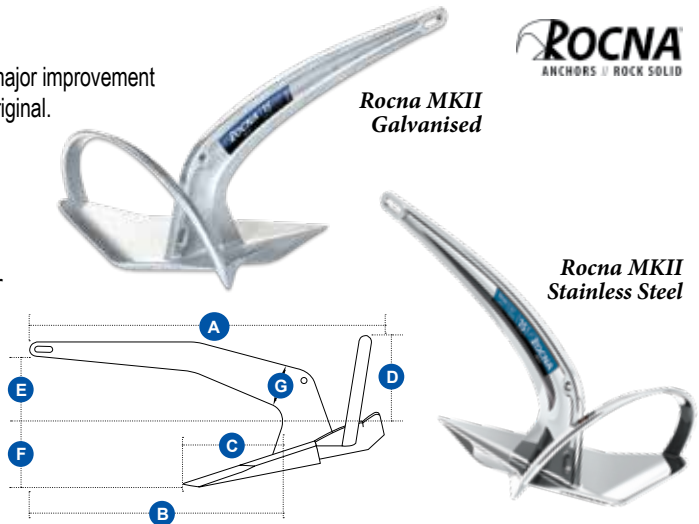

Part No.		Anchor Size		Dimensions (mm)								Sugg. Boat Size (m)
Galvanised	Stainless Steel	(lb)	(kg)	A	B	C	D	E	F	G	Width	
JPW96261	JPW96275	9	4	529	365	152	132	99	93	66	271	4-7
JPW96262	JPW96276	13	6	606	418	174	151	114	107	75	310	5-9
JPW96263	JPW96277	20	9	694	479	199	172	130	122	86	355	6-11
JPW96264	JPW96278	27	12	763	527	219	190	143	135	95	390	7-12
JPW96265	JPW96279	33	15	822	568	236	204	154	145	102	421	8-14
JPW96266	JPW96280	44	20	905	625	260	225	170	160	112	463	9-16
JPW96267	JPW96281	55	25	975	673	280	242	183	172	121	499	10-18
JPW96268	JPW96282	73	33	1069	738	307	266	200	189	133	547	12-22
JPW96269	JPW96283	88	40	1140	787	328	284	214	201	141	583	14-24
JPW96270	JPW96284	110	50	1228	848	353	305	230	217	152	628	16-26

The Vulcan Anchors

The Vulcan anchor infuses as many as possible of the proven performance advantages of the Original Rocna, while being specifically designed to fit a wider range of vessels. The omission of a roll-bar along with a carefully designed shank ensures a snug fit on the bow.

- Platforms, bowsprits, prods, stays, and other protrusions are easily cleared.
- Self-rights on the seabed without the use of a roll-bar.
- Encourages self-launching / self-stowing.
- Lower 'V' edge cuts into the seabed for secure burial.
- Available in sizes from 4 kg (9 lb) – 55 kg (121 lb).

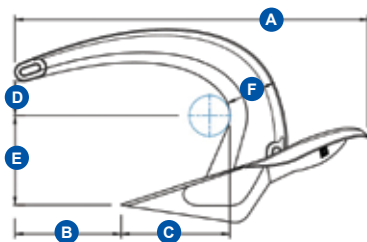

Part No.		Anchor Size		Dimensions (mm)							Sugg. Boat Size (m)
Galvanised	Stainless Steel	(lb)	(kg)	A	B	C	D	E	F	Width	
JPW96230	JPW96241	9	4	472	142	145	46	119	67	258	4 - 7
JPW96231	JPW96242	13	6	541	163	167	53	136	77	296	5 - 9
JPW96232	JPW96243	20	9	619	186	191	61	156	88	339	6 - 10
JPW96233	JPW96244	27	12	681	205	210	67	172	97	373	7 - 12
JPW96234	JPW96245	33	15	734	221	226	72	185	104	402	8 - 14
JPW96235	JPW96246	44	20	808	243	249	79	204	115	442	9 - 16
JPW96236	JPW96247	55	25	870	262	268	85	220	124	476	10 - 18
JPW96237	JPW96248	73	33	955	287	294	93	241	136	522	12 - 22
JPW96238	JPW96249	88	40	1018	306	313	100	257	145	557	14 - 24
JPW96239	JPW96250	121	55	1132	340	349	111	286	161	619	16 - 26

Fixed-Head Power Anchor

High-grade steel construction for maximum strength/holding power. Based on a similar design as the Delta anchor.

- Shank profile and ballasted tip makes it self-launching and ensure that it will set quickly.
- Fluke has a large surface area and flares outward at the rear to provide greater resistance to dragging and twisting forces.
- Galvanised sizes: 4kg (8.8 lb) - 50kg (110 lb)
- Stainless steel sizes: 4kg (13.2 lb) - 25kg (55 lb)

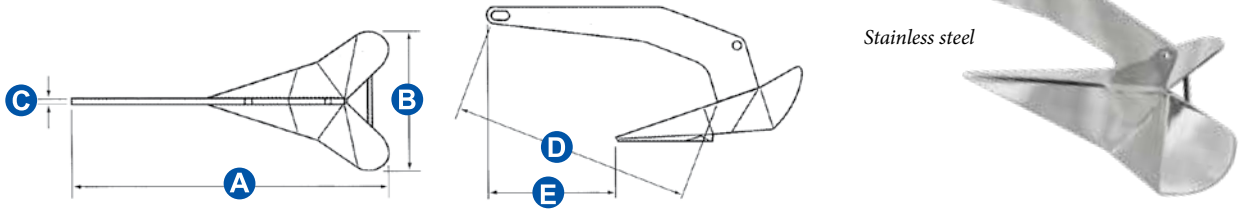

Part No.		Anchor Size		Dimensions (mm)					Suggested Boat Size (m)
Galvanised	Stainless Steel	(lb)	(kg)	A	B	C	D	E	
JPW96104	JPW96155	8.8	4	530	230	8	390	210	6-7
JPW96106	JPW96156	13.2	6	610	260	10	440	250	7-8
JPW96110	JPW96157	22	10	700	310	15	500	310	8-10
JPW96116	JPW96158	35.2	16	820	350	15	590	330	10-14
JPW96120	JPW96159	44	20	880	390	16	665	360	15-17
JPW96125	JPW96160	55	25	945	415	16	715	390	18-20
JPW96132	-	70	32	1025	455	20	775	425	19-21
JPW96140	-	80	40	1105	490	20	885	440	20-24
JPW96150	-	110	50	1175	525	20	890	480	24-26

Claw Anchor

The Claw anchor is available in either high-grade galvanised steel or 316-grade stainless steel.

- Designed based on anchors used to secure oil rigs in the North Sea.
- Sets effortlessly - self-aligning on bottom to roll upright and holds in a variety of seabeds (mainly sand and mud).
- Stows easily on the bow roller of most boats.
- Galvanised sizes: 1kg (2.2 lb) - 50kg (110 lb)
- Stainless steel sizes: 1kg (2.2 lb) - 30kg (66 lb)

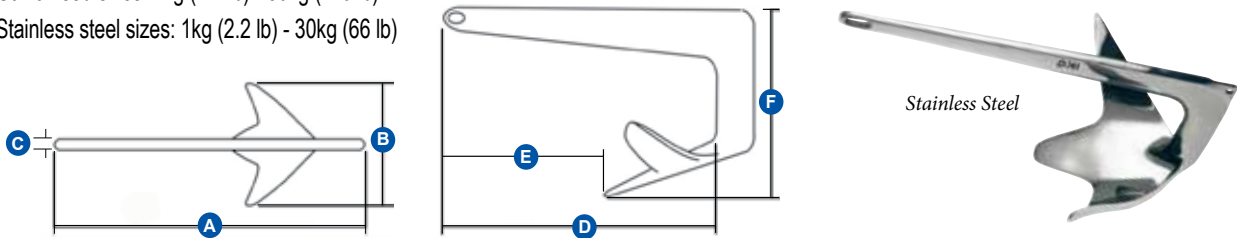

Part No.		Anchor Size		Dimensions (mm)						Suggested Boat Size (m)
Galvanised	Stainless Steel	(lb)	(kg)	A	B	C	D	E	F	
JPW58	JPW1070	2.2	1	290	200	6	265	155	150	0-3
JPW59	JPW1071	4.4	2	360	250	8	325	190	180	3-6
JPW60	JPW1072	11	5	470	310	10	415	270	230	5-9
JPW61	JPW1073	16.5	7.5	495	330	10	430	280	260	8-10
JPW62	JPW1074	22	10	540	360	11	465	305	285	9-11
JPW63	JPW1075	33	15	625	420	13	530	340	330	11-13
JPW64	JPW1076	44	20	700	460	17	590	365	335	12-15
JPW65	JPW1077	66	30	825	525	19	705	425	395	14-19
JPW66	-	110	50	955	645	23	780	490	440	17-22

AnchorX Delta-Style Slider Anchor

Affordable and reliable, this delta-style anchor with ballasted tip sets quickly and holds firmly in sand, mud, and reef.

- Sliding shank design for easy retrieval.
- Plough tip for fast set and strong holding.
- Self-launching, low-centre-of-gravity design for immediate setting.
- Flared fluke surface for increased resistance to dragging and twisting.
- Based on a similar design as the "Delta" anchor.
- Four sizes for small to medium boats.

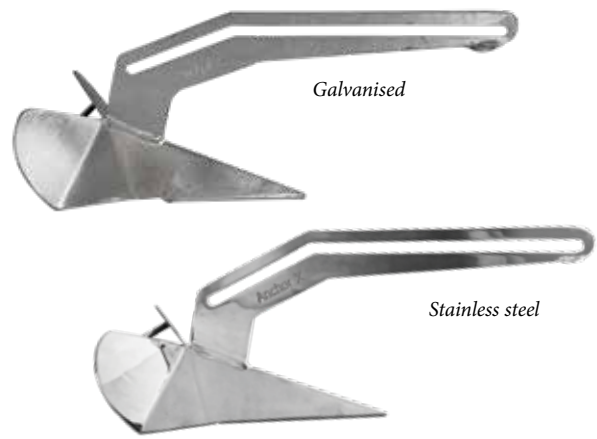

Welded stop prevents chain running underneath

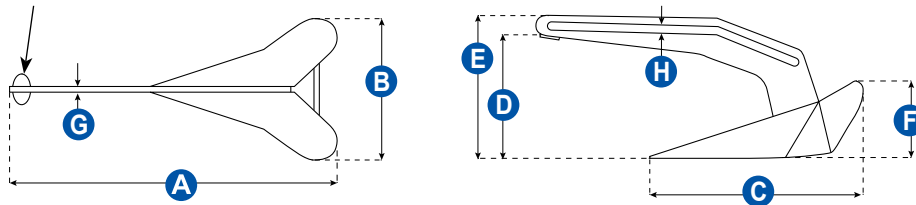

Part No.		Anchor Size (kg)	Dimensions (mm)								Suggested Boat Size (m)
Galvanised	Stainless Steel		A	B	C	D	E	F	G	H	
JPW96178	JPW96184	4	512	252	341	196	230	120	8	12	6-7
JPW96179	JPW96185	6	581	261	354	220	255	124	12	12	7-8
JPW96180	JPW96186	10	679	302	409	259	293	143	12	14	8-10
JPW96181	JPW96187	16	777	360	484	296	339	172	12	14	10-14

AnchorX Claw Slider Anchor

Reliable holding power and easy retrieval at an entry-level price. The self-aligning claw fluke set quickly and hold securely in sand, mud, and silt.

- Sliding shank design for easy retrieval.
- Claw-style flukes self-align and set quickly.
- Self-launching, low-centre-of-gravity design for immediate setting.
- Curved fluke for increased resistance to dragging and twisting.
- Based on a popular claw design.
- Four sizes for small to medium boats.



Welded stop prevents chain running underneath

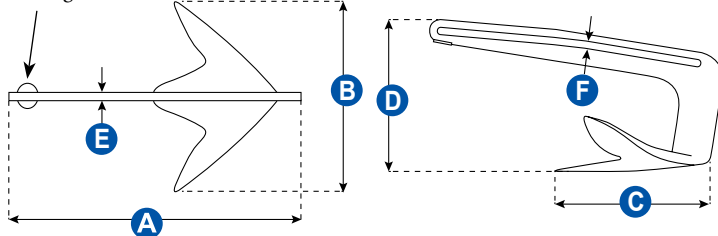

Part No.		Anchor Size (kg)	Dimensions (mm)						Suggested Boat Size (m)
Galvanised	Stainless Steel		A	B	C	D	E	F	
JPW96166	JPW96172	5	462	290	230	240	8	12	5-9
JPW96167	JPW96173	7.5	532	340	283	275	8	17	8-10
JPW96168	JPW96174	10	585	380	311	300	16	17	9-11
JPW96169	JPW96175	15	659	410	330	341	16	17	11-13

Ankerplex High Performance Folding Anchor

The Ankerplex Folding Anchor is a modern anchor at a competitive price, offering high holding power, instant setting, and great repositioning capability. It consists of three top-quality standardized flat sheet metal pieces that, with a simple coupling and securing with a shackle, assembles into a solid and self-contained three-dimensional unit.

The Ankerplex anchor suits all types of boats including kayaks, jet skies or small tinnys, to large motorboats, sailboats and yachts.

- Manufactured from 304-grade stainless steel, hot-dipped galvanised steel or marine grade aluminium.
- Fabricated from sheet metal without bending, welding or fixing screws.
- Self-launching.
- Secure and stable in various seabeds.
- No tools required for assembly.
- No moving parts
- Easy to disassemble and stores flat.



JPW96036
Flat Line with Chain

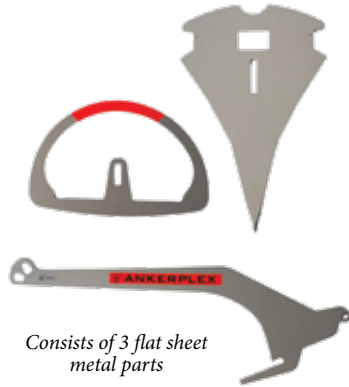

Consists of 3 flat sheet metal parts

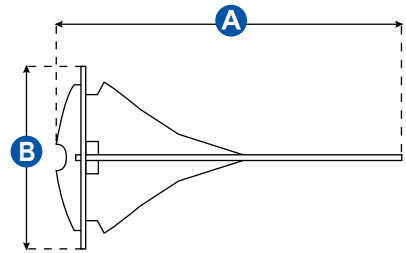
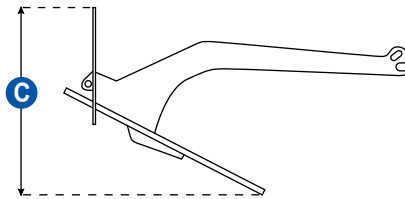

Part No.		Model	Anchor Size (kg)	Dimensions (mm)			Suggested Boat Size (m)
Stainless Steel	Galvanised			A	B	C	
JPW96040	JPW96041	1	1.5	412	199	206	up to 5
JPW96044	JPW96045	2	5	595	291	301	6.5
JPW96048	JPW96049	8	8	664	325	335	9
JPW96053	JPW96054	11	11	794	389	402	11
JPW96059	JPW96060	16	16	876	428	443	12
JPW96064	JPW96065	20	20	955	467	482	13
JPW96071	JPW96072	27	27	1004	491	506	15



Part No.	Model	Anchor Size (kg)	Dimensions (mm)			Suggested Boat Size (m)
			A	B	C	
JPW96046	2	1.7	595	291	301	up to 5.5
JPW96050	8	2.6	664	325	335	7.5
JPW96055	11	4.5	794	389	402	10
JPW96061	16	6.9	876	428	443	11
JPW96066	20	8.2	955	467	482	12
JPW96073	27	11.9	1004	491	506	14
JPW96077	31	13.7	1075	525	540	15
JPW96081	50	16.5	1180	577	595	20
JPW96085	60	20	1298	635	655	22

Ankerplex Anchor Transport & Stowage Bag

Safely stow and transport Ankerplex anchors in a durable, well-fitted synthetic bag designed specifically for each model.

Part No.	Suits Model
JPW96031	1
JPW96032	5 - 8
JPW96033	11 - 16
JPW96034	20 - 27



Bull Anchor - Galvanised

Engineered for performance and durability, this anchor features a large concave blade that delivers superior grip on the seabed, ensuring vessels remain steadfast in any conditions.

- Made from quality galvanised steel.
- Suitable for all ocean floor environments such as sand, rocks & reef.
- Stability-enhancing roll bar.
- Precision chisel tip.

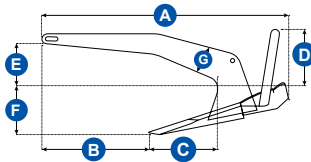

Part No.	Anchor Size (kg)	Dimensions (mm)							Sugg. Boat Size (m)
		A	B	C	D	E	F	G	
JPW96094	4	547	234	154	133	96	103	75	4-6
JPW96095	6	630	270	170	150	102	123	80	5-8
JPW96096	10	724	312	204	174	130	133	90	7-11
JPW96097	15	830	360	235	205	145	156	100	8-12

Sand Anchor (Danforth)

Popular design for sand and mud bottoms. Lays flat for easy storage.

- Fitted with retrieval eye for ease of removal if snagged.
- Hot-dipped galvanised finish.

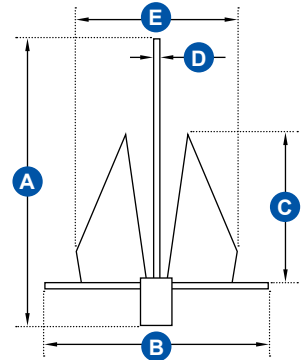

Part No.	Anchor Size		Dimensions (mm)					Sugg. Boat Size (m)
	(lb)	(kg)	A	B	C	D	E	
JPW04	4	1.8	485	305	215	5	185	3
JPW05	6	2.7	500	330	240	7	260	4
JPW06	8	3.6	500	340	245	7	265	5
JPW07	10	4.5	520	340	265	8	265	6
JPW08	13	5.9	565	400	300	10	310	7
JPW25	16	7.3	595	430	320	10	320	8
JPW27	27	12.2	795	500	335	12	330	11
JPW28	35	15.9	890	565	380	12	365	13

Aluminium "NORD" Anchor 1kg Red

Lightweight anchor offering exceptional grip and reliable holding power in mud, sand, and rocky bottoms. Its easy assembly and disassembly make it convenient for storage.

- Perfect for small motor boats, inflatable boats, kayaks, SUP's, Jet Ski's & personal watercrafts.
- Made from durable aluminum with high-grade marine powder coating.
- Excellent adhesion and corrosion resistance.
- Bright color enhances visibility.



Patented dual-piece design



Part No.
JPW96163

Aluminium "NORD" Anchor Kit 1kg

This kit includes the 1kg "NORD" anchor above, complete with 15m x 6mm rope, 0.5m x 6mm chain, 1x bow shackle & small float all packed neatly in a small storage bag.



Part No.
JPW1009

Sand Anchor and Rope Kits

This complete sand anchoring kit includes:

- Hot-dipped galvanised sand anchor.
- 3m length of galvanised general link chain.
- Two galvanised shackles.
- 50m silver rope with stainless steel thimble spliced in one end.

Kit comes packaged in retail display box (except JPW1005)



Part No.	Anchor Size		Rope Dia. (mm)	Chain Dia. (mm)	Shackle Size (mm)	Suggested Boat Size (m)
	(lb)	(kg)				
JPW1001	4	1.8	6	6	6	3
JPW1002	6	2.7	6	6	6	4
JPW1003	8	3.6	8	6	8	5
JPW1004	10	4.5	10	8	10	6
JPW1005	13	5.9	10	8	10	7

Reef Anchor - Standard

Popular lightweight anchor for fishing. Includes four prongs supplied straight that must be bent by hand for the first use. Suitable for light weight, small crafts.

- Hot-dipped galvanised finish.

Part No.	A (mm)
JPW90	6
JPW91	8
JPW92	10
JPW93	12

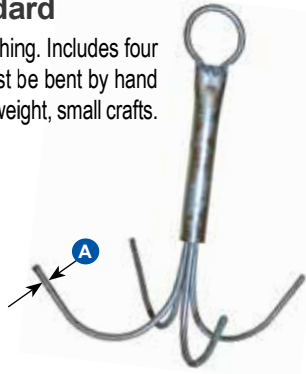

Reef Anchor - Folding

This reef anchor is supplied with four pre-bent prongs that can be twisted to fold flat after use for safe and easy stowage. Suitable for light weight, small crafts.

- Hot-dipped galvanised finish.

Part No.	A (mm)
JPW105	8
JPW106	10
JPW107	12

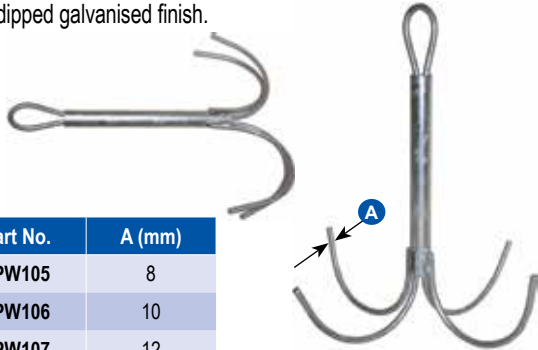

Grapnel Folding Anchor

Ideal for small boats, dinghies and jet skis. With no sharp edges, it folds and unfolds in seconds and stores compactly with locking collar.

- Hot-dipped galvanised finish.

Part No.	Anchor Size	
	(lb)	(kg)
JPW95	3.3	1.5
JPW96	5.5	2.5
JPW97	7.1	3.2
JPW98	8.8	4

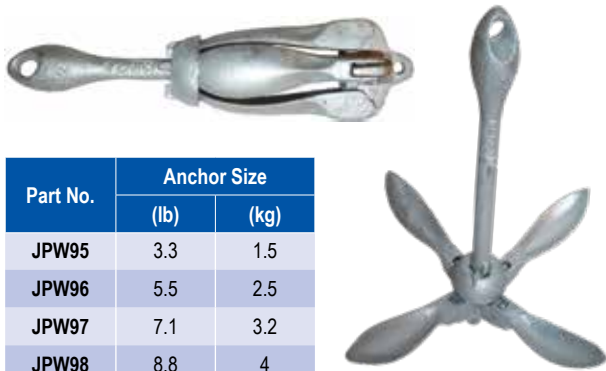

Grapnel Hook

Four-prong throw grapnel welded in one piece from 316-grade stainless steel, designed for rock and reef setting. Can also be used to retrieve rope lines or other items fallen overboard.

- Overall size (H x W): 250 x 200mm
- Small and light.

Part No.	Anchor Size
JPW1080	1kg

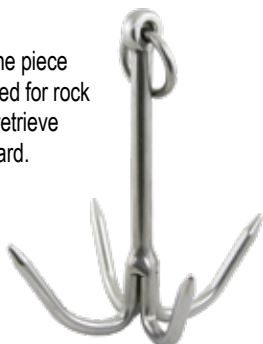

Sea Anchors

Reduces movement and controls the amount of wind drift in open water.

- Tough PVC with reinforced webbing.
- The large and extra large sizes feature a stainless steel D ring pre-stitched into the end of the straps for stronger use.

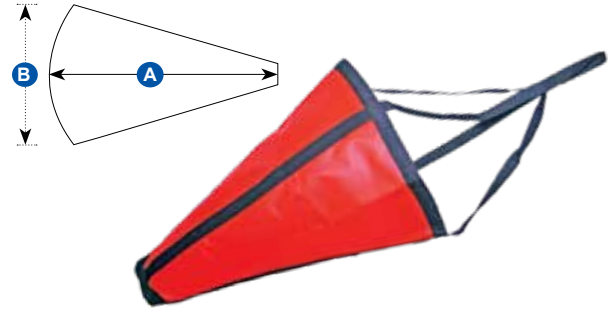

Part No.	Size	Dimensions (mm)		Suggested Boat Size (m)
		A	B	
JPW11205	Small	600	530	4 - 5
JPW11206	Medium	800	700	6 - 7
JPW11207	Large	1070	1100	8 - 9
JPW11208	Extra Large	1350	1400	10

Anchor Chain Claws - Stainless Steel

Made from 316-grade stainless steel, chain claws will stop the anchor chain grinding on the bow roller when moored overnight.

Part No.	Suits Chain (mm)	Length (mm)	Width (mm)
JPW4910	6 - 8	125	65
JPW4911	10 - 12	165	100



Kong Anchor Swivel Connectors - Stainless Steel

Heavy duty, manufactured from polished 316-grade stainless steel.

- Sleek, slim snag-free profile designed to go over bow rollers smoothly.
- Passes through hawse pipes without snagging.

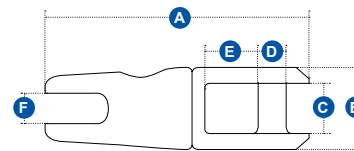

* SWL (safe working load) is approx 25% of breaking load.

Part No.	Suits Chain (mm)	Dimensions (mm)						SWL (kg)	Break Load (kg)
		A	B	C	D	E	F		
JPW4981	6 - 8	93	28	16	10	19	9	850	2500
JPW4982	8 - 12	117	36	22	13	23	13	2000	5000
JPW4983	12 - 14	155	66	35	18	30	17	3000	9500
JPW4984	16 - 20	190	86	43	22	42	20	5000	20000

Anchor Single Swivel Connectors - Stainless Steel

Single swivel anchor to chain connectors.

- Made from 316-grade stainless steel.
- Slides over bow rollers for easy retrieval.

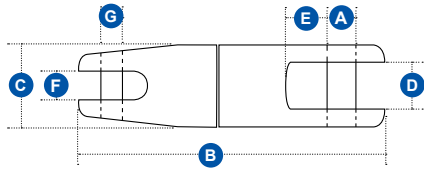

* SWL (safe working load) is approx 25% of breaking load.

Part No.	Suits Chain (mm)	Dimensions (mm)							SWL* (kg)
		øA	B	C	D	E	F	G	
JPW4921	6-8	9	90	27	15	23	10	7	850
JPW4922	10-12	10.5	115	35	18	30	14	10.5	1350

Soft Rope Shackles

The soft rope shackle is made with UHMWPE (Ultra high molecular weight polyethylene) and ideal for hooking up halyards, connecting sheets or attaching blocks. It is lighter than a metal shackle without losing any strength.

- Fast, secure connection and simple to use.
- Highly resistant to abrasion.
- Locks closed when under load.
- Requires no tools to undo.



Part No.	Width (mm)	Length (mm)	Breaking Strain (kg)
JPW4972	6	100	3300
JPW4973	8	100	5500
JPW4974	10	150	8100
JPW4975	12	150	12500
JPW4976	14	150	15000

Anchor Double Swivel Connectors - Stainless Steel

Double swivel anchor to chain connectors prevents chain and anchor from twisting when setting and retrieving anchor.

- Made from 316-grade stainless steel.
- Slides over bow rollers for easy retrieval.

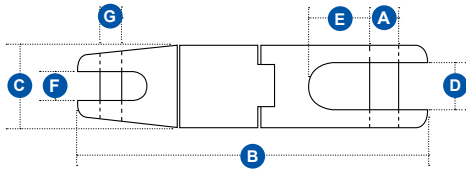

* SWL (safe working load) is approx 25% of breaking load.

Part No.	Suits Chain (mm)	Dimensions (mm)							SWL* (kg)
		øA	B	C	D	E	F	G	
JPW4926	6-8	9	133	28	16	21	9	7	850
JPW4927	10-12	10.5	168	38	18	28	14	10.5	1350

Eye and Eye Swivel - Stainless Steel

Heavy-duty eye and eye swivel, made from 316-grade stainless steel.

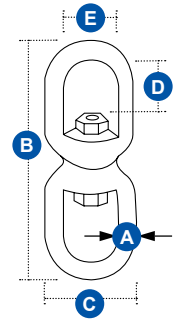

* SWL (safe working load) is approx 25% of breaking load.

Part No.	Dimensions (mm)					SWL* (kg)
	A	B	C	D	E	
JPW4958	6	65	21	15	15	335
JPW4959	8	90	35	22	20	500
JPW4960	10	115	44	27	24	875

AnchorX Double Swivel Connector - Stainless Steel

Snag-free design slides easily over bow rollers and through hawse pipes and allows both the anchor and chain to rotate independently.

- Made from polished 316-grade stainless steel.



Part No.	Suits Chain (mm)	Length (mm)	Width (mm)	Height (mm)	SWL* (kg)
JPW4925	6-8	133	29	29	850

Jaw and Jaw Swivel Shackle - Stainless Steel

316-grade stainless steel with shackle pin at each end for easy connection.

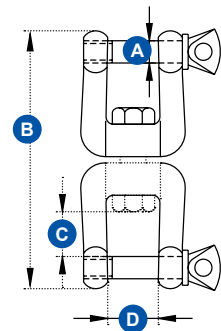

Part No.	Dimensions (mm)			
	A	B	C	D
JPW4936	6	66	11	13
JPW4937	8	88	17	16
JPW4938	10	110	21	20
JPW4939	12	146	28	24

Thimbles - Galvanised

Galvanised steel thimbles in a range of sizes (12mm-38mm).

- Traditional style and suitable for splicing into anchor ropes etc.

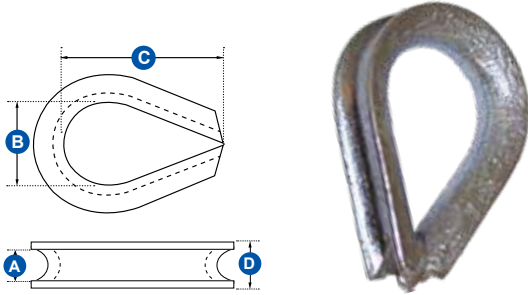

Note: "A" measurement is the diameter of the rope that suits the thimble.

Part No.	Dimensions (mm)			
	A	B	C	D
JPW4000	12	30	70	18
JPW4001	14	40	85	20
JPW4002	16	41	92	22
JPW4004	20	50	115	28
JPW4005	22	52	130	29
JPW4006	24	65	144	32
JPW4008	28	74	168	39
JPW4010	32	96	202	44
JPW4013	38	106	244	52

Thimbles - Stainless Steel

Traditional rope style thimbles suitable for splicing into small anchor ropes.

- Made with 304-grade stainless steel.

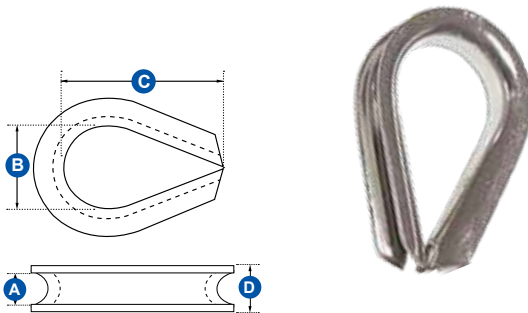

Note: "A" measurement is the diameter of the rope that suits the thimble.

Part No.	Dimensions (mm)			
	A	B	C	D
JPW520	6	13	23	9
JPW521	8	20	34	13
JPW522	10	25	40	15
JPW523	12	28	50	18
JPW525	14	33	53	20
JPW526	16	38	66	23
JPW529	20	47	84	27
JPW531	24	54	85	33

D Shackles - Galvanised

Load rated galvanised steel with yellow pin.

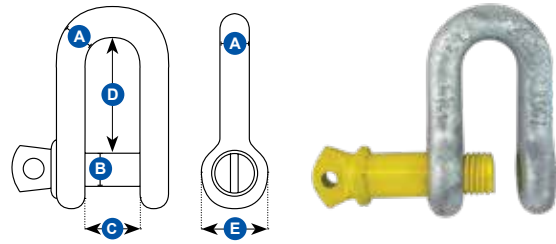

* SWL (safe working load) is approx 25% of breaking load.

Part No.	Dimensions (mm)				SWL* (kg)
	øA	øB	C	D	
JPW6692	9	9.5	12	25	750
JPW6694	10	11	16	31	1000
JPW6697	12	13	18	36	1500
JPW6699	14	16	20	40	2000

Captive Pin D Shackles - Stainless Steel

316-grade stainless steel with captive pin.

- For general use, not rated for lifting.

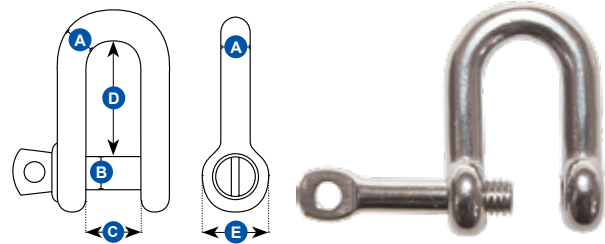

Part No.	Dimensions (mm)				
	øA	øB	C	D	E
JPW4890	5	10	18	11	10
JPW4891	6	13	24	14	12
JPW4892	8	17	26	16	16
JPW4893	10	21	36	20	20

Long 'D' Shackles - Stainless Steel

316-grade stainless steel with solid round standard screw pin and long body.

- For general use, not rated for lifting.

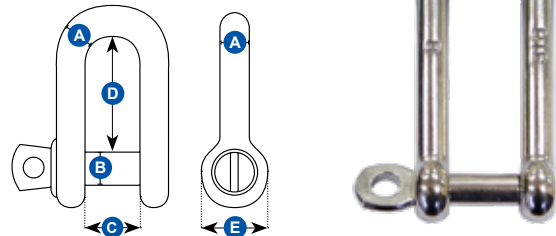

Part No.	Dimensions (mm)			
	øA	øB	C	D
JPW4840	6	6	12	48
JPW4841	8	8	16	64
JPW4842	10	10	20	80
JPW4843	12	12	24	96

D Shackle - Galvanised

For general use, not rated for lifting. Screw collar pin drilled with hole for security tie wire.

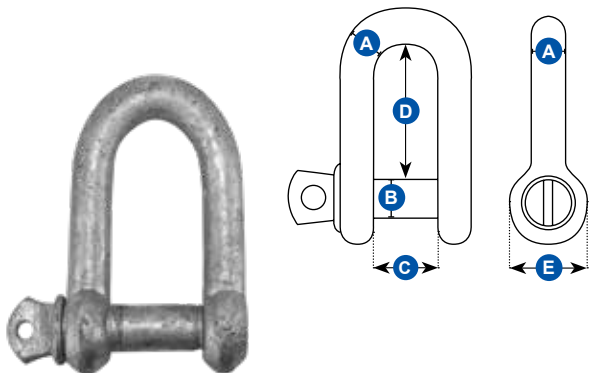

* SWL (safe working load) is approx 25% of breaking load.

Part No.	Dimensions (mm)					SWL* (kg)
	Ø A	Ø B	C	D	E	
JPW550	5	5	10	19	10	-
JPW551	6	6	13	25	12.5	80
JPW552	8	8	18	32	15.5	100
JPW553	10	10	19	37	18.5	200
JPW554	12	12	26	47	24	300
JPW555	16	16	30	61	30	500
JPW556	20	20	35	72	34	800
JPW557	25	25	49	94	44.5	1100

Bow Shackle - Galvanised

Screw collar pin drilled with hole for security tie wire.

• For general use, not rated for lifting.

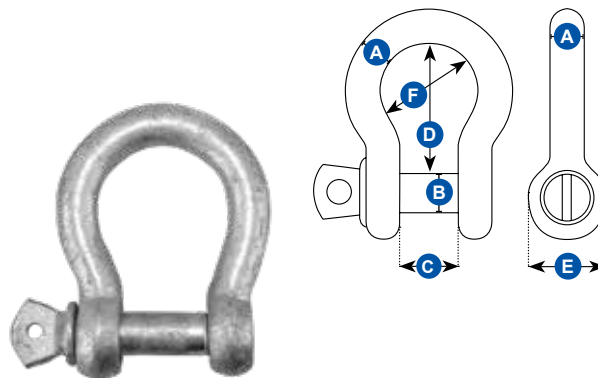

* SWL (safe working load) is approx 25% of breaking load.

Part No.	Dimensions (mm)						SWL* (kg)
	Ø A	Ø B	C	D	E	F	
JPW592	6	6	14	25	12	19	80
JPW593	8	8	16	32	15	24	100
JPW594	10	10	20	39	18	29	200
JPW595	12	12	25	46	22	35	300
JPW596	14	14	27	60	26	43	500
JPW597	16	16	29	65	26	47	650
JPW598	20	20	35	76	32	58	800
JPW599	25	25	46	104	42	77	1100

D Shackle - Stainless Steel

316-grade stainless steel. Solid round standard screw pin with hole for security tie wire.

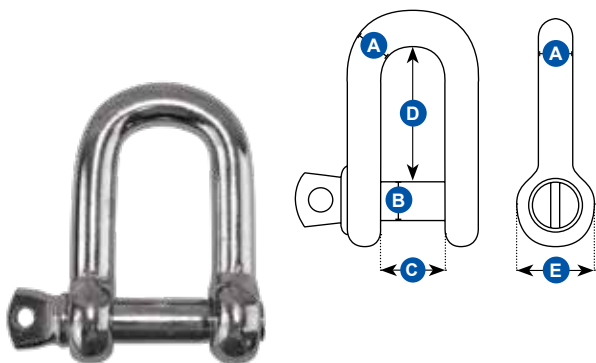

* SWL (safe working load) is approx 25% of breaking load.

Part No.	Dimensions (mm)					SWL* (kg)
	Ø A	Ø B	C	D	E	
JPW4872	5	5	10	18	9.5	250
JPW4873	6	6	11	24	13.5	375
JPW4874	8	8	17	33	15.5	625
JPW4875	10	10	20	40	19.5	1000
JPW4876	12	12	23	48	24.5	1500
JPW4877	16	16	34	64	30.5	2750
JPW4878	20	20	40	76	39	3750

Bow Shackle - Stainless Steel

316-grade stainless steel. Screw collar pin drilled with hole for security tie wire.

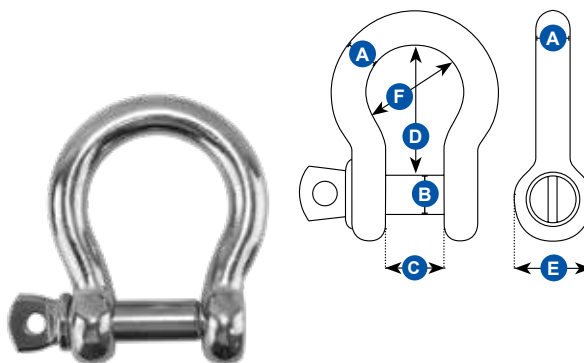

* SWL (safe working load) is approx 25% of breaking load.

Part No.	Dimensions (mm)						SWL* (kg)
	Ø A	Ø B	C	D	E	F	
JPW4882	5	5	10	19	10	15	250
JPW4883	6	6	12	24	12	18	375
JPW4884	8	8	16	32	16	24	625
JPW4885	10	10	22	40	20	30	1000
JPW4886	12	12	25	45	24	38	1600
JPW4887	16	16	32	62	32	56	1750
JPW4888	20	20	38	76	41	66	1900
JPW4889	25	25	50	102	48	87	2200

Galvanised Chain - Short Link

Heavy-duty, hot-dipped galvanised short link chain calibrated to DIN766 international standard to ensure proper fit for most metric windlasses.

- Low-carbon steel specifically designed for anchoring.
- Check manufacturer's specifications prior to purchase.
- Sold in cut lengths per metre.

Once cut to length, a re-stocking fee will apply if returned.

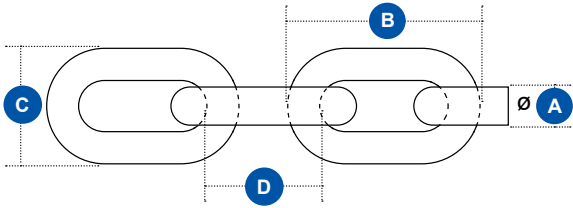

Part No.	Dimensions (mm)				SWL (kg)
	Ø A	B	C	D	
JPW499	6	30.6	20	18.5	612
JPW502	8	40	26	24	1122
JPW503	10	47.2	34	28	1836
JPW504	13	59.6	40	36	2550

Galvanised Chain - General Link

This ISO-proof coil chain is low-carbon steel general-purpose anchor chain. Used when high-tensile strength is not required.

- Hot-dipped galvanised finish.
- Sold in cut lengths per metre.

Once cut to length, a re-stocking fee will apply if returned.

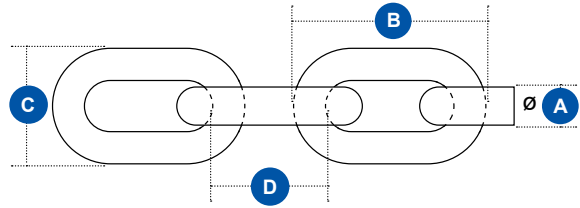

Part No.	Dimensions (mm)				SWL (kg)
	Ø A	B	C	D	
JPW490	6	40.7	23.5	26.1	320
JPW491	8	49.1	29.5	32.2	530
JPW492	10	58.7	36.2	39.1	830
JPW493	12	70	44	46	1350

Grade L Galvanised Chain - Short Link

This Grade L low-carbon, short-link steel chain has been hot-dip galvanised to prevent abrasion and corrosion. Load-tested calibrated chain fits most Australian windlasses.

- Sold in cut lengths per metre.

Once cut to length, a re-stocking fee will apply if returned.

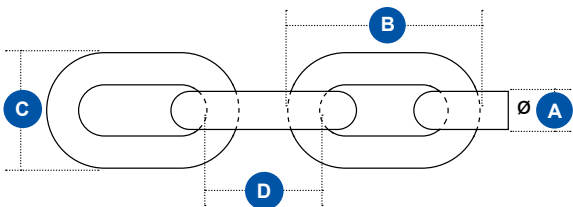

Part No.	Dimensions (mm)				SWL (kg)	Proof Load (kg)	Breaking Load (kg)
	Ø A	B	C	D			
JPW506	6	30.6	21.5	18.5	320	800	1280
JPW508	8	40	26.5	24	530	1325	2120
JPW509	10	50	32.5	30	816	2015	5047

Stainless Steel Chain - Short Link

Glossy heavy-duty 316-grade stainless steel short-link chain calibrated and load tested to DIN766 international standard.

- Ideal for anchor chain or fits most metric windlasses.
- Sold in cut lengths per metre.

Once cut to length, a re-stocking fee will apply if returned.

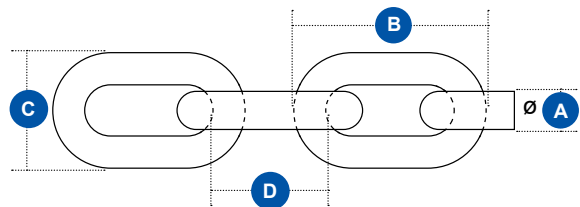

Part No.	Dimensions (mm)				SWL (kg)	Proof Load (kg)	Breaking Load (kg)
	Ø A	B	C	D			
JPW480	6	30.6	20	18.5	612	1224	2448
JPW481	8	40	26	24	1122	2244	4385
JPW482	10	47.2	34	28	1836	3671	7342

Fender Lanyard - Double Braided Polyester Blue

Fender lines/lanyards made from high quality UV-stabilised 16-strand double braid blue polyester, professionally hand-spliced 150mm loop with whipped end to prevent fraying.

- Soft on hands and easy to handle.



Supplied in a hank for easy storage

Part No.	Diameter (mm)	Length (m)	Colour
JPW6874	10	1.8	Blue

Fender Lanyards - Double Braided Polyester Black

Fender lines/lanyards made from high quality UV-stabilised 16-strand double braid black polyester, professionally hand-spliced 300mm loop with whipped end to prevent fraying.

- Soft on hands and easy to handle.



Supplied in a retail hang sell plastic bag

Part No.	Diameter (mm)	Length (m)	Colour	Breaking Strain (kg)
JPW6862	10	2	Black	1600
JPW6863	14	2	Black	2900
JPW6864	14	3	Black	2900

Dock Lines - Double Braided Nylon

White, soft and easy to handle. Great elasticity, good abrasion resistance and high strength. Spliced with a large loop on one end to throw over a cleat or bollard.



Blister-packed



Part No.	Dia (mm)	Length (m)	Breaking Strain (kg)
JPW6870	10	4.5	1587
JPW6871	10	7.6	1587

Dock Lines - Double Braided Polyester

Dock lines made from high quality UV-stabilised 16-strand double braid black polyester with a professionally hand-spliced 300mm loop with whipped end to prevent fraying.

- Strong and soft to handle.
- Pre-made in various lengths to suit your requirements.



Supplied in a mesh bag for easy storage

Part No.	Diameter (mm)	Length (m)	Breaking Strain (kg)
JPW6850	10	6	1600
JPW6851	10	10	1600
JPW6852	12	6	2000
JPW6853	12	10	2000
JPW6854	14	10	2900
JPW6855	14	15	2900
JPW6856	16	10	3800
JPW6857	16	15	3800
JPW6858	18	10	4500
JPW6859	18	16	4500
JPW6860	20	16	5100

Polyethylene 3 Strand Anchor Rope with Thimble - 50m Coils

Polyethylene rope is extremely versatile for fishing and marine applications and is most commonly used as anchor rope for trailer boats.

- Floats with slack line for easy pickup of mooring lines.
- 100% polyethylene with high abrasion resistance in a soft medium lay.
- 50m coils supplied with a stainless steel thimble spliced at one end.



Part No.	Dia (mm)	Length (m)	Breaking Strain (kg)
JPW600	6	50	390
JPW601	8	50	680
JPW602	10	50	1050
JPW603	12	50	1250
JPW604	14	50	1580

Polyethylene 3 Strand Anchor Rope with Thimble - Hanks

- Supplied in 50m hanks for easy storage on shelf.

Part No.	Dia (mm)	Length (m)	Breaking Strain (kg)
JPW627	8	50	680
JPW628	10	50	1050



Rubber Mooring Springers

Reduces jarring and cushions shock load.

- Suits mooring lines up to 19mm (3/4").
- Withstands 453kg (1000 lb) of pull.



Part No.	Size	Length (mm)
JPW3890	Large	750
JPW3900	Small	550

Unimer Mooring Spring Compensators



EPDM rubber with cleat shaped locking mechanisms to prevent slipping.

- Excellent weather and UV resistance.



Part No.	Suits Rope (mm)	Length (mm)
JPW3885	10 - 12	332
JPW3886	12 - 16	416
JPW3887	14 - 18	520
JPW3888	20 - 24	600

Unimer U-Cleat Mooring Spring Compensators



Features a unique removable locking mechanism that allows for fitting without a free end of the line.

- High quality EPDM rubber.
- Glass fibre reinforced polyamide inserts.
- Excellent weather and UV resistance.



Spare Plastcleats Available



Part No.	Suits Rope (mm)	Length (mm)	Spare Plastcleat
JPW3881	10 - 12	329	JPW3892
JPW3882	12 - 16	412	JPW3893
JPW3883	16 - 20	516	JPW3894

Unimer Mooring Line Smart Snubber



Fits directly on to the line without the need of a free end, and allows for easy adjustments.

- Excellent weather and UV resistance.
- Blue polyurethane material.
- Sold as a pair.



Part No.	Suits Rope (mm)	L x W x H (mm)
JPW3878	16	70 x 40 x 40
JPW3879	20	87 x 50 x 50



Boat Hook - Fixed Length

Grab lines and fend off easily.

- Black nylon double-hook head and rolled-grip handle base.
- 30mm anodised aluminium tube.



Part No.	Tube Dia (mm)	Length (m)
JPW681	30	1.8

Boat Hook - Floating Telescopic

- Internally threaded hook for attaching brush heads.
- Black nylon single-hook head and rolled-grip handle base.
- 30mm anodised aluminium tube.
- Telescopes quickly and twist-locks securely.

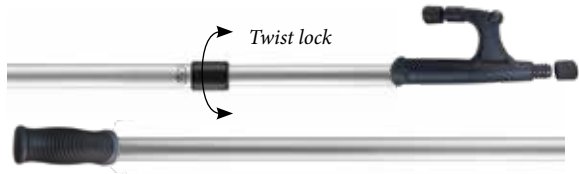

Part No.	Tube Dia (mm)	Length (m)
JPW677	30	1.2 - 2.1

Boat Hook - Floating Telescopic

- Black nylon double-hook head and rolled-grip handle base.
- 30mm anodised aluminium tube.
- Telescopes quickly and twist-locks securely.

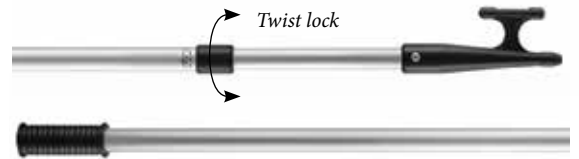

Part No.	Tube Dia (mm)	Length (m)
JPW679	30	1.2 - 2.1

Replacement Boat Hook Head

Boat hook replacement head to fit externally over a 25mm (1") tube.

- Made from black heavy-duty nylon plastic.



Part No.	Inside Length (mm)	Dia (mm)
JPW682	190	25

R-Series Boat Fenders

Sidewind Marine R-Series fenders are constructed using moulded vertical ribs to enhance strength and minimise rolling.

- Constructed from premium marine-grade UV-stabilised vinyl for superior durability.



Plain White

White with Blue Tops



Nitrogen Filled Boat Fenders



Features MicroGuard protection which guarantees your fender will last longer without rotting, or developing mould or mildew.

Pin-type valve can be easily inflated using a standard sports pump.

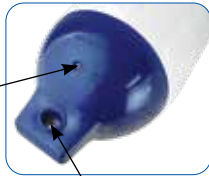

Reinforced rope eyes for vertical or horizontal use

Part No.		Model	Length (mm)	Dia (mm)	Eye Dia. (mm)
Plain White	White with Blue Tops				
JPW3950	JPW3955	R10	410	115	12
JPW3951	JPW3956	R20	507	140	16
JPW3952	JPW3957	R30	585	165	19
JPW3953	JPW3958	R40	685	215	33

R-Series Boat Fenders - White with Blue Tops 2 Packs

2x boat fenders with a 2m double braided nylon dock line attached to each.

Part No.	Model
JPW3941	R10
JPW3942	R20
JPW3943	R30
JPW3944	R40



R-Series Boat Fenders - White 3 Pack

This retail pack includes 3x R20 boat fenders.

Part No.	Model
JPW3949	R20



R-Series Boat Fenders - White with Blue Tops Packs with Round Buoy

Packs of multiple boat fenders with round 9-inch buoy. Each R-series fender comes with a 2m double braided nylon dock line attached.



JPW3942P
6x R20

JPW3944P
2x R40

Part No.	Model	Pack Qty
JPW3942	R20	6
JPW3944	R40	2

Heavy-duty Buoys

Sidewind Marine round fender buoy made from a seamless construction and high quality marine-grade vinyl for extra strength and reliability. For use with sail boats, wakeboard boats, PWC, larger boats and commercial applications.

- Reinforced rope eye for vertical or horizontal use (ø 25mm).



Features MicroGuard protection which guarantees your fender will last longer without rotting, or developing mould or mildew.



Red/Black

Part No.	Height (mm)	Diameter (mm)
JPW3971	300	230
JPW3972	380	305
JPW3973	490	380
JPW3974	620	480
JPW3975	800	585



White/Blue

Part No.	Height (mm)	Diameter (mm)
JPW3971W	300	230



Fender Inflation Needles 3pack

Inflation needles for pumping up the Sidewind range of boat fenders.

Part No.
JPW3927



Fender Baskets - Stainless Steel



Each basket features two adjustable rail-mount brackets that can attach to rails of 19mm to 40mm diameter.

- Made from solid 5mm marine-grade 316 stainless steel rods.
- Hand-polished to a mirror finish.
- Can be flush-mounted using brackets supplied.

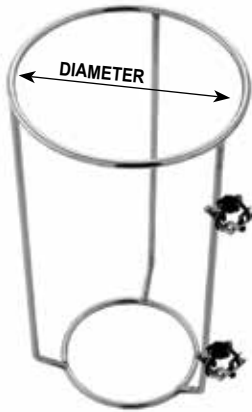

Part No.	Dia (mm)	Height (mm)
JPW3935	170	380
JPW3936	210	410
JPW3937	275	550

Fender Baskets - Heavy-duty Stainless Steel

For mounting on the rails of cruisers in the 8 - 14m (25 - 45ft) range.

- Robust construction with 10mm diameter 304-grade rounded stainless steel.
- Stainless steel rail clamps to suit 22mm, 25mm and 32mm diameter rails.

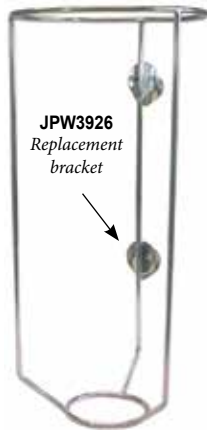

Part No.	Dia (mm)	Height (mm)
JPW3920	200	450
JPW3921	250	490
JPW3922	300	620
JPW3926	Replacement bracket	

Padded Boat Fenders - Flat/Contour

A great alternative to round boat fenders, that can roll upwards or get pushed aside. These will remain snug against your hull.

- The contoured model wraps vertically to protect smaller boat gunwale.
- Very durable and easier to stow than standard bulky fenders.
- Foam filled.



Part No.	Type	Dimensions L x W x H (mm)
JPW3910	Flat	660 x 165 x 64
JPW3912	Contour	610 x 165 x 64

Dock Edge Fenders



Made from soft, pliable UV-stabilised PVC and can be easily attached to either metal or wooden docks.

- Has a pin-type sports air valve for easy inflation or adjusting air pressure.
- JPW3984: 3 piece set includes 2x straight & 1x corner.

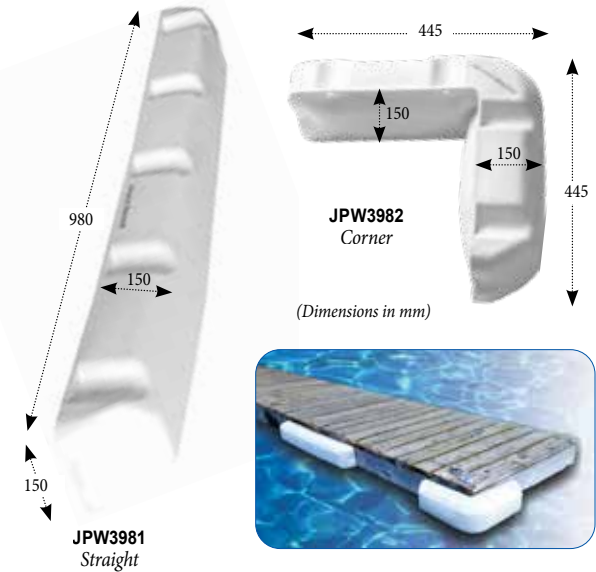

Features MicroGuard protection which guarantees your fender will last longer without rotting, or developing mould or mildew.



Part No.	Type	Dimensions L x W x H (mm)
JPW3981	E40 Straight	980 x 150 x 150
JPW3982	E45 Corner	445 x 445 x 150
JPW3984	3 Piece Set (includes 2x straight & 1x corner)	

Premium Edge Mount Dock Fenders



Made from heavy duty, premium grade marine white PVC, designed to wrap around the dock and cover both top and sides.

- Resistant to chalking, splitting, deflating or crushing.
- Reinforced mounting holes.
- One piece design.
- Pin-type air valve.

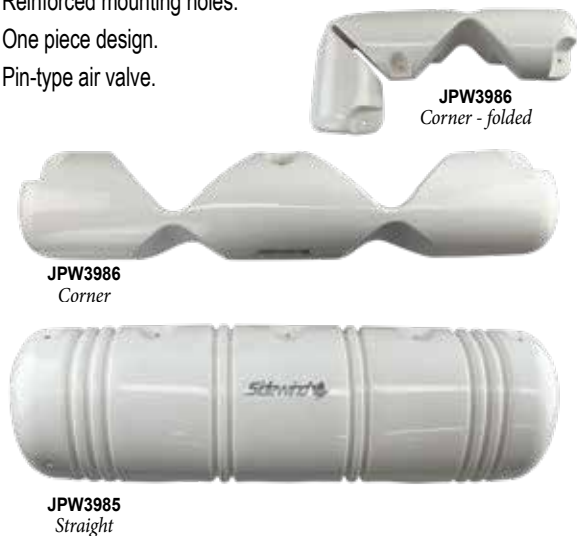

Part No.	Type	Dimensions L x W x H (mm)
JPW3985	E60 Straight	870 x 170 x 230
JPW3986	E65 Corner	800 x 180 x 180

D-Section Pontoon Fenders - PVC

Suitable as gunwale for larger watercraft, as fender material for boat pens, buffers on a wharf or jetty, or on trucks as a rear bumper.

- Made from high UV-stabilised, white PVC.
- Sold in pre-cut lengths.



Part No.	Length (m)	Dimensions (mm)		
		A	B	C
JPW9750	1.5	90	57	10
JPW9751	5	90	57	10
JPW9752	10	90	57	10
JPW9818	5	70	41	8
JPW9819	10	70	41	8

P-Section Pontoon Fender - White PVC

Suitable as gunwale for larger watercraft, as fender material for boat pens, buffers on a wharf/jetty or on trucks as a rear bumper.

- Made from high UV-stabilised, white PVC.
- Sold in pre-cut lengths.



Part No.	Length (m)
JPW9911	5
JPW9912	10
JPW9913	15
JPW9914	20
JPW9915	25
JPW9916	30

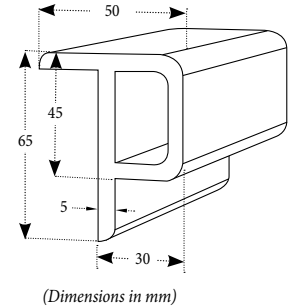

D-Fender PVC Rub Rail 'BUMP'

The BUMP D fender has been developed to provide a quick and simple installation using hidden fixings without compromising impact resistance. Handles curves and a 80mm radius without the need to mitre either track or body.

- Easier to fit than traditional D Fenders.
- Available in either 53mm (white or black) or 65mm (white) width profiles.
- Internal track (**JPW9828**) fits both fender profile bodies (sold separately).
- 316-grade stainless steel end cap (sold separately).



Part No.	Suits BUMP Profile	Length (m)
JPW9828	Both 53mm & 65mm	3

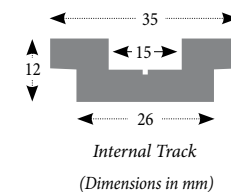
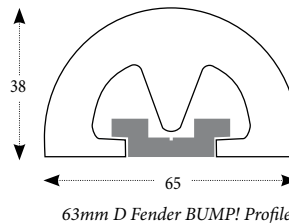
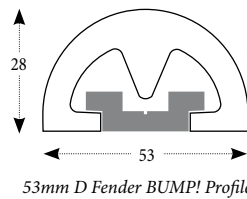
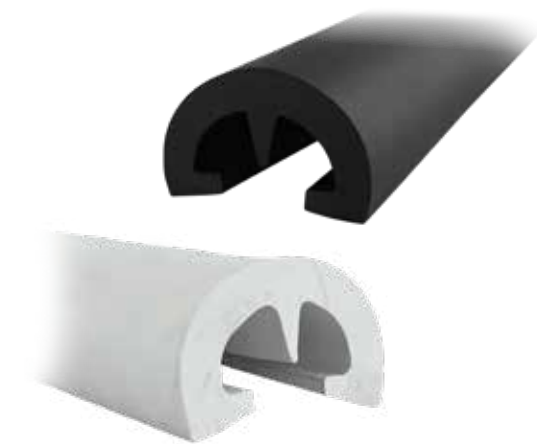

BUMP! fenders wrap neatly around most curves.



Stainless Steel End caps



Part No.			Length (m)
53mm Profile White	53mm Profile Black	65mm Profile White	
JPW9870	JPW9870B	JPW9880	3
JPW9871	JPW9871B	JPW9881	6
JPW9872	JPW9872B	JPW9882	9
JPW9873	JPW9873B	JPW9883	12
JPW9874	JPW9874B	JPW9884	15
JPW9875	JPW9875B	JPW9885	18
-	-	JPW9886	21
-	-	JPW9887	24

Part No.	Suits BUMP Profile
JPW9837	53mm
JPW9838	65mm

Gunwale - PVC 38mm

Gunwale profile fender trim available in white UV-stabilised PVC polymer, suitable for long-lasting wear and tear in harsh marine environments.

- PVC insert (JPW9831) to suit 38mm profile - sold separately.

Part No.	Type	Length (m)
JPW9821	38mm Aluminium Gunwale Profile	3.65
JPW9820	38mm White PVC Gunwale Profile	3.65

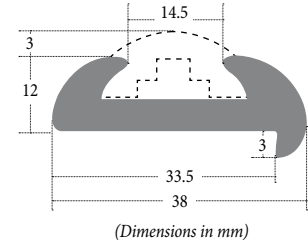

JPW9820
PVC Profile with
JPW9831 PVC insert

Gunwale Inserts - Black PVC 38mm

Gunwale insert made from black PVC material. Fits inside 38mm gunwale profile boat trim.

Note: Once product has been cut it is non-refundable.

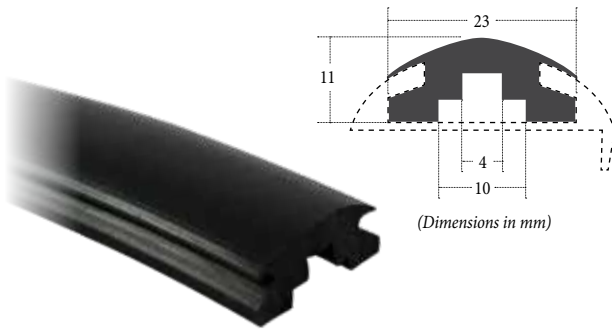

Part No.	Description	Length
JPW9831	Black Rubber Insert to suit 38mm Aluminium & PVC gunwale profile	Cut per metre

Gunwale End Cap - Stainless Steel 38mm

Cast 316-grade stainless steel end caps to suit 38mm profile.

- End caps sold individually.

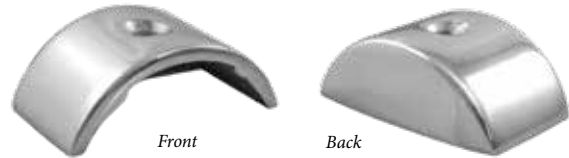

Part No.	Description
JPW9768	End Cap to suit 38mm Aluminium & PVC profile

Gunwale - Aluminium 50mm

Gunwale profile fender trim made from brushed anodised aluminium extrusion. Looks great on any boat.

- PVC insert (JPW9829) to suit 50mm profile - sold separately.

Part No.	Type	Length (m)
JPW9823	50mm Aluminium Gunwale Profile	3.65

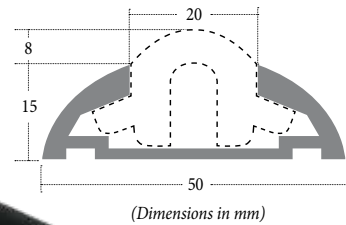

JPW9823
Aluminium Profile
with JPW9829 PVC insert

Gunwale Inserts - Black PVC 50mm

Gunwale insert made from black PVC material. Fits inside 50mm profile gunwale boat trim.

- The insert is sold per metre and is cut to order.

Note: Once product has been cut it is non-refundable.

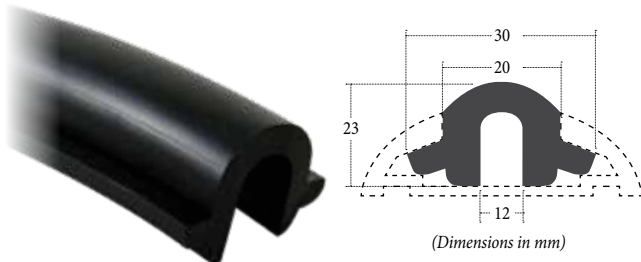

Part No.	Description	Length
JPW9829	Black Rubber Insert to suit 50mm Aluminium profile	Cut per metre

Gunwale End Cap - Stainless Steel 50mm

Cast 316-grade stainless steel end caps to suit 50mm profile.

- End caps sold individually.



Part No.	Description
JPW9769	End Cap to suit 50mm Aluminium & PVC profile

Gunwale Rub Rail Rigid PVC 38mm

Stylish and easy to fit, 38mm white or black PVC rigid body with a small return, designed to carry 19mm stainless steel insert for a classic look.

- Two different profile types available.
- Sold in pre-cut lengths of 3.65m.
- Stainless steel insert (**JPW9832**) to suit both 38mm profiles - sold separately.

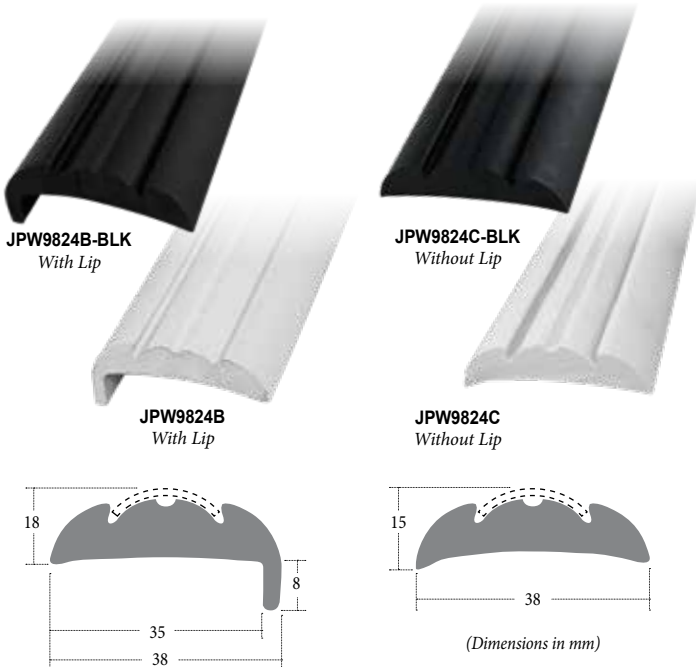

Part No.		Profile Type	Length (m)
White	Black		
JPW9824B	JPW9824B-BLK	Type B (with lip)	3.65
JPW9824C	JPW9824C-BLK	Type C (without lip)	3.65



Stainless Insert 19mm to suit 38mm PVC Rigid Gunwale

1.5mm thick 316-grade stainless steel with pre-drilled 5mm mounting holes, usually found every 150mm.

- Sold in pre-cut lengths of 3.65m.

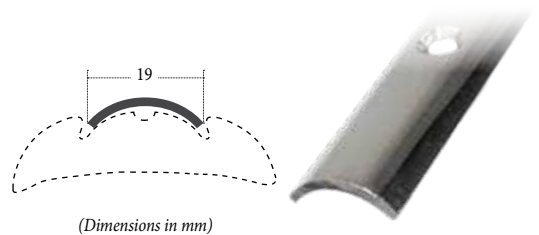

Part No.	Description	Length (m)
JPW9832	Stainless Insert 19mm	3.65

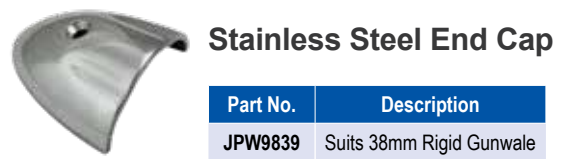

Gunwale White Rub Rail Rigid PVC 50mm

Stylish and easy to fit, 50mm white PVC rigid body with a large return, designed to carry 25mm stainless steel insert for a classic look.

- Sold in pre-cut lengths of 3.65m.
- Stainless steel insert (**JPW9833**) to suit 50mm profile - sold separately.

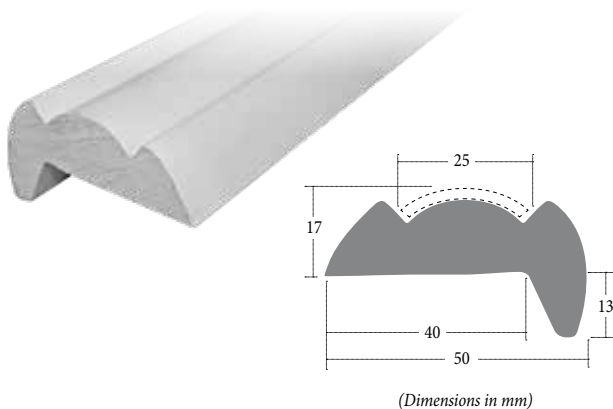

Part No.	Description	Length (m)
JPW9825	50mm Rigid PVC Rub Rail	3.65



Stainless Insert 25mm to suit 50mm PVC Rigid Gunwale

The 25mm stainless steel insert suits 50mm body. Includes pre-drilled 5mm mounting holes, usually found every 150mm.

- 1.5mm thick 316-grade stainless steel.
- Sold in pre-cut lengths of 3.65m.

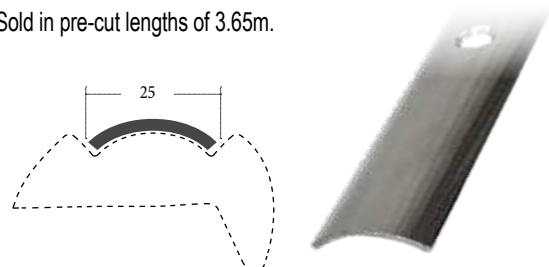

Part No.	Description	Length (m)
JPW9833	Stainless Insert 25mm to suit 50mm PVC Rigid Gunwale	3.65

PVC Gunwale 35mm - Black

UV-stabilised PVC gunwale boat bumper trim sold in pre-cut lengths.

- Longer lengths available on request.

Part No.	Length (m)
JPW9840	8
JPW9841	10
JPW9842	12
JPW9843	14
JPW9844	16
JPW9845	18
JPW9846	20
JPW9847	22

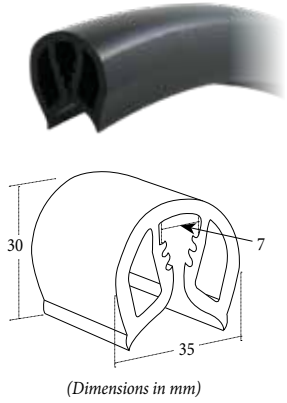

Gunwale End Caps - Nylon

End caps to suit boat gunwale trim sizes 30mm, 35mm and 40mm.

- Made from a durable nylon plastic that won't rust or crack.
- Available in black or white.



Part No.		Suits Gunwale
Black	White	
JPW9776	JPW9775	30mm
JPW9772	JPW9771	35mm
JPW9810	JPW9809	40mm

PVC Gunwale 40mm - Black or White

UV-stabilised PVC gunwale boat bumper trim sold in pre-cut lengths.

- Longer lengths available on request.



Part No.		Length (m)
Black	White	
JPW9850	JPW9891	8
JPW9851	JPW9892	10
JPW9852	JPW9893	12
JPW9853	JPW9894	14
JPW9854	JPW9895	16
JPW9855	JPW9896	18
JPW9856	JPW9897	20
JPW9857	JPW9898	22

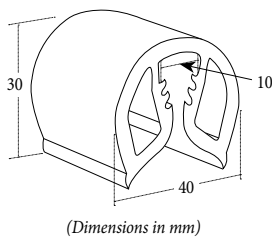

Gunwale Corner Caps - Nylon

Corner caps to suit boat gunwale trim sizes 30mm, 35mm and 40mm.

- Made from a durable nylon plastic that won't rust or crack.
- Available in black or white.



Part No.		Suits Gunwale
Black	White	
JPW9778	JPW9777	30mm
JPW9774	JPW9773	35mm
JPW9817	JPW9816	40mm

PVC Gunwale 40mm - White with Black Strip

UV-stabilised PVC gunwale boat bumper trim sold in pre-cut lengths.

- Longer lengths available on request.

Part No.	Length (m)
JPW9860	8
JPW9861	10
JPW9862	12
JPW9863	14
JPW9864	16
JPW9865	18
JPW9866	20
JPW9867	22

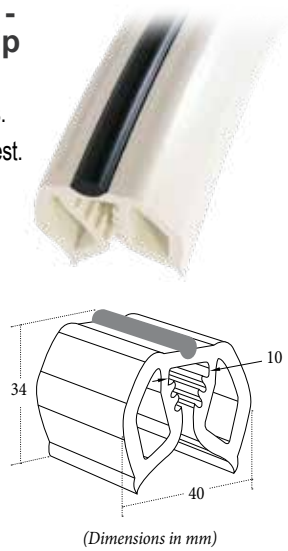

Gunwale End and Corner Caps - Stainless Steel

316-grade stainless steel cast end caps and corner caps to suit 30mm, 35mm and 40mm boat gunwale boat trim.

Part No.	Type	Suits Gunwale
JPW9760	End	35mm
JPW9765	End	40mm
JPW9763	Corner	35mm
JPW9766	Corner	40mm



Gunwale End and Corner Caps - PVC 40mm

Black or white, made from plastic to suit 40mm boat gunwale trim.

- Available in Black or White

Part No.	Type	Colour
JPW9811	End	White
JPW9812	End	Black
JPW9814	Corner	Black
JPW9815	Corner	White

