

# HULL, DECK & CABIN HARDWARE 04

## CABIN HARDWARE

|                                  |             |
|----------------------------------|-------------|
| Hinges .....                     | 4.02 - 4.03 |
| Barrel Bolts.....                | 4.04        |
| Latches and Fasteners.....       | 4.04 - 4.05 |
| Ring-Pulls.....                  | 4.05        |
| Cupboard & Door Catches .....    | 4.05        |
| Saddle Eye Straps .....          | 4.06        |
| Grab Handle & Rails .....        | 4.06 - 4.07 |
| Drink Holders .....              | 4.08 - 4.09 |
| Glove Boxes & Storage Cases..... | 4.10        |
| Access & Storage Hatches .....   | 4.11        |
| Vents .....                      | 4.12        |

## HULL & DECK HARDWARE

|                                       |             |
|---------------------------------------|-------------|
| Instrument Mounts .....               | 4.13        |
| Phone Mounts .....                    | 4.13        |
| Tablet Mount Kits.....                | 4.13        |
| Bow Rollers .....                     | 4.14 - 4.15 |
| Bollards .....                        | 4.16        |
| Fairleads .....                       | 4.16        |
| Cleats .....                          | 4.17 - 4.18 |
| Lifting Ring.....                     | 4.18        |
| Scuppers .....                        | 4.19        |
| Brackets for Live Bait Tanks.....     | 4.19        |
| Fuel Breathers.....                   | 4.20        |
| Deck Fillers.....                     | 4.20 - 4.21 |
| Inspection Ports .....                | 4.22        |
| Deck Plates .....                     | 4.23        |
| Hawse Pipes .....                     | 4.24        |
| Trim Rings & Slop Stoppers.....       | 4.24        |
| Bungs & Bases.....                    | 4.24 - 4.27 |
| Canopy Fittings .....                 | 4.28 - 4.30 |
| Rail Fittings .....                   | 4.31        |
| Flag Pole & Antenna Bases .....       | 4.32        |
| Boat Rego Numbers and Letters .....   | 4.33        |
| Rail Mount Board Rack .....           | 4.33        |
| Davits .....                          | 4.33        |
| Telescopic Ladders .....              | 4.34 - 4.37 |
| Folding Step .....                    | 4.37        |
| Transducer Brackets & Covers .....    | 4.38        |
| Radar & Accessory Mounts.....         | 4.39        |
| StopGull Air Seagull Deterrents ..... | 4.40 - 4.41 |



**Cast Stainless Steel Concealed Hinge with Stud**

316-grade smooth polished stainless steel with M6 fixing studs.

| Part No. | Dimensions L x W (mm) |
|----------|-----------------------|
| JPW19178 | 94 x 49               |
| JPW19179 | 76 x 40               |



**Cast Stainless Steel Concealed Door Hinge with Stud**

316-grade smooth polished stainless steel with M6 fixing studs.

| Part No. | Dimensions L x W (mm) |
|----------|-----------------------|
| JPW19188 | 72 x 65               |
| JPW19189 | 83 x 65               |



**Cast Stainless Steel External Hinge with Stud**

316-grade smooth polished stainless steel with M6 fixing studs.

| Part No. | Dimensions L x W (mm) |
|----------|-----------------------|
| JPW19191 | 84 x 45               |



**Hinges - Black Coated Stainless Steel**

316-grade heavy duty stainless steel with black PVD coating.

- Sold individually.
- Six 5mm countersunk fastening holes.

| Part No. | Dimensions L x W (mm) |
|----------|-----------------------|
| JPW19181 | 76 x 38               |
| JPW19182 | 100 x 38              |



**Cast Hinges - Stainless Steel**

316-grade heavy duty stainless steel.

- Sold individually.
- 5mm countersunk fastening holes.

| Part No. | Dimensions L x W (mm) |
|----------|-----------------------|
| JPW19080 | 98 x 23               |
| JPW19081 | 160 x 27              |



**Square Butt Hinge - Black Coated Stainless Steel**

316-grade heavy duty stainless steel with black PVD coating.

- Sold individually.
- Four 5mm countersunk fastening holes.

| Part No. | Dimensions L x W (mm) |
|----------|-----------------------|
| JPW19185 | 38 x 38               |



**Square Butt Hinges - Cast Stainless Steel**

- Cast 316-grade heavy duty stainless steel.
- Sold individually.
- Four 5mm countersunk fastening holes.

| Part No. | Dimensions L x W (mm) |
|----------|-----------------------|
| JPW19082 | 38 x 38               |
| JPW19112 | 50 x 50               |



**Door Hinges - Cast Stainless Steel**

- Cast 316-grade heavy duty stainless steel.
- 3mm thick and highly polished.
- Sold individually.
- Five 5mm countersunk fastening holes.

| Part No. | Dimensions L x W (mm) |
|----------|-----------------------|
| JPW19083 | 56 x 38               |
| JPW19115 | 76 x 38               |



**Cast Hinges - Stainless Steel**

316-grade heavy duty stainless steel.

- Sold individually.
- Six 5mm countersunk fastening holes.

| Part No. | Dimensions L x W (mm) |
|----------|-----------------------|
| JPW19078 | 76 x 38               |
| JPW19079 | 102 x 38              |



**10mm Offset Hinges - Cast Stainless Steel**

Cast 316-grade heavy duty stainless steel.

- Sold individually.
- Five 5mm countersunk fastening holes.

| Part No. | Dimensions L x W (mm) |
|----------|-----------------------|
| JPW19113 | 57 x 38               |
| JPW19114 | 70 x 38               |



### Separating Hinge - Stainless Steel

Cast 316-grade heavy duty stainless steel take apart hinge.

- Sold individually.
- Four 5mm countersunk fastening holes.



JPW19085

| Part No. | Type  | Dimensions L x W (mm) |
|----------|-------|-----------------------|
| JPW19084 | Right | 90 x 38               |
| JPW19085 | Left  | 90 x 38               |



JPW19084

### Separating Hatch Hinges - Stainless Steel

Cast 316-grade stainless steel with an in-built stopper to hold the hinge upright.

- Has a removable pin to separate.
- Sold individually.
- 5mm countersunk fastening holes.



JPW19117

| Part No. | Type     | Dimensions L x W (mm) |
|----------|----------|-----------------------|
| JPW19117 | Straight | 75 x 56               |
| JPW19118 | Angled   | 82 x 76               |



JPW19118

### Hasp and Staple Latch with Swivel Lock - Stainless Steel

Very heavy duty cast 316-grade stainless steel with highly polished finish and rotatable staple to lock hasp in place.

- Suitable for padlocks up to 8mm.
- 5mm countersunk fastening holes.



Swivel lock

| Part No. | Dimensions L x W (mm) |
|----------|-----------------------|
| JPW4698  | 76 x 25               |

### Hasp and Staple Latches - Stainless Steel

Pressed 316-grade stainless steel hasp and staple latches with rotatable staple to lock the hasp in place or standard fixed eye.

- Suitable for padlocks up to 8mm.
- 5mm countersunk fastening holes.



JPW4702

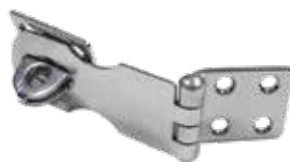

JPW4704

| Part No. | Type        | Dimensions L x W (mm) |
|----------|-------------|-----------------------|
| JPW4702  | Swivel Lock | 70 x 25               |
| JPW4704  | Fixed Eye   | 70 x 25               |

### Locking Hasp Latch - Stainless Steel

304-grade stainless steel with lockable hasp.

- 29 x 41mm base area behind lock.
- Seven 4mm countersunk fastening holes.

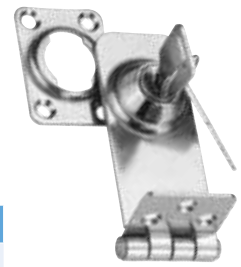

| Part No. | Dimensions L x W (mm) |
|----------|-----------------------|
| JPW4697  | 76 x 30               |

### Toggle Adjustable Hatch Latches - Stainless Steel

Adjustable toggle latch 316-grade stainless steel with cam action lever.

- Length adjusts by turning threaded bolt.
- 5mm countersunk mounting holes.

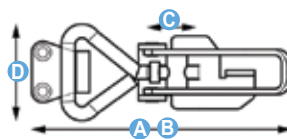

| Part No. | Dimensions (mm) |         |    |    |
|----------|-----------------|---------|----|----|
|          | A (max)         | B (min) | C  | D  |
| JPW4700  | 75              | 65      | 10 | 26 |
| JPW4703  | 95              | 85      | 10 | 26 |
| JPW4701  | 125             | 115     | 15 | 36 |

### Anti-Rattle Hatch Fastener - Stainless Steel

Lever action, silent anti-rattle type with an eye for a padlock. Heavy duty cast 316-grade stainless steel.

- 5mm countersunk fastening holes.

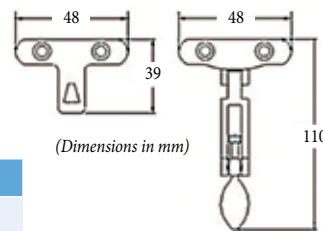

(Dimensions in mm)

| Part No. |
|----------|
| JPW4705  |



### Hatch Fastener Eye Lock Cast 316-Grade Stainless Steel

Cast 316-grade stainless steel hatch fastener flat mounting with eye for a padlock.

- 4mm countersunk fastening holes.

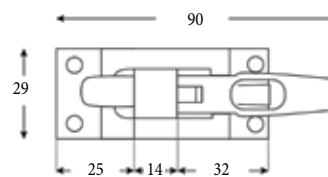

(Dimensions in mm)

| Part No. |
|----------|
| JPW4707  |



**Barrel Bolts - Stainless Steel**

Highly polished heavy duty cast 316-grade stainless steel barrel bolts.

- 5mm countersunk fastening holes.



| Part No. | Dimensions L x W (mm) |
|----------|-----------------------|
| JPW4691  | 90 x 38               |
| JPW4693  | 108 x 38              |

**Barrel Spring Bolt - Black Nylon**

Non-corrosive nylon spring-loaded barrel bolt.

- Ideal for marine applications.

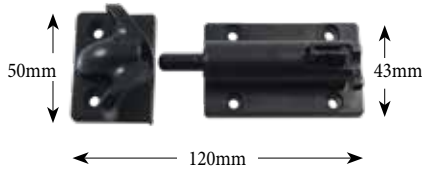

| Part No. |
|----------|
| JPW5424  |

**Flush Hatch Latches - Stainless Steel**

Heavy duty 316-grade stainless steel hatch latch pull handle.

- The locking arm is height adjustable.

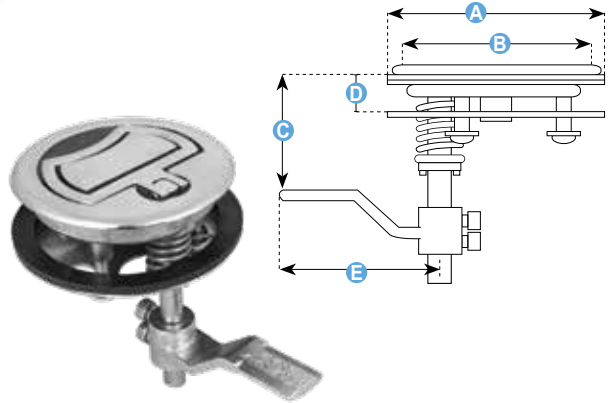

| Part No. | Dimensions (mm) |     |         |         |    |
|----------|-----------------|-----|---------|---------|----|
|          | A Ø             | B Ø | C       | D       | E  |
| JPW19048 | 60              | 50  | 37 - 70 | 15 - 25 | 74 |
| JPW19049 | 90              | 76  | 37 - 70 | 8 - 30  | 74 |

**Heavy Duty Swivel Latch - Stainless Steel**

Heavy duty, highly polished 316-grade stainless steel door latch with spring loaded locking pin to secure in place.

- Long thick handle swivels 360 degrees.
- Four 6mm countersunk fastening holes.

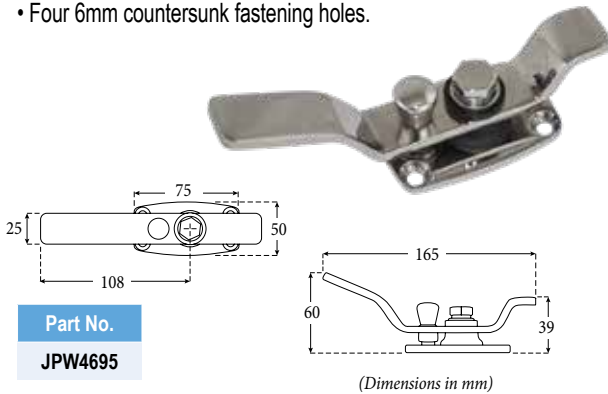

| Part No. |
|----------|
| JPW4695  |

**Flush Hatch Latch with Turning Lock**

Black ABS plastic flush hatch latch with concealed fastenings. The heavy duty locking arm is height adjustable with a turning lock design.

- Includes water resistant seal.

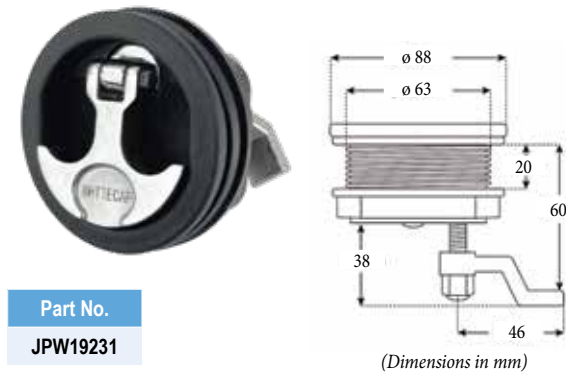

| Part No. |
|----------|
| JPW19231 |

**Cast Stainless Steel Hatch Ring-Pull**

316-grade heavy duty stainless steel hatch latch pull handle. The locking arm is height adjustable and secured with a stainless steel set screw.

- Set the height adjuster between 30-100mm.
- 5mm countersunk fastening holes.

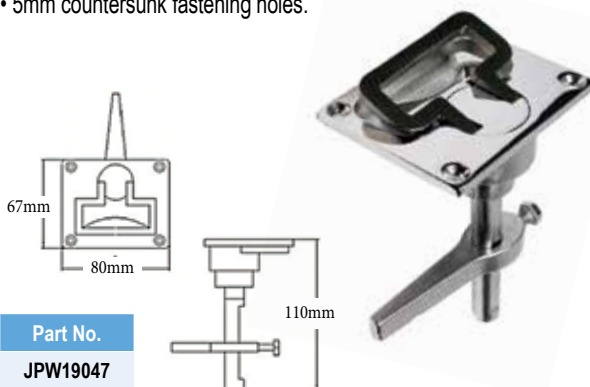

| Part No. |
|----------|
| JPW19047 |

**Flush Slam Latch - Stainless Steel**

Cast 316-grade stainless steel flush mounting, low profile and self-latching; ideal for galley doors and drawers. Lift ring with spring return and 1mm spacer ring.

- Door Thickness: 11-20mm.
- 50mm cut-out diameter.

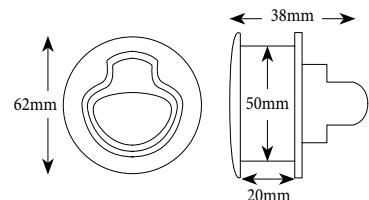

| Part No. |
|----------|
| JPW4708  |

### Cast Stainless Steel Ring-Pull with Spring Return

Flush pull with spring, cast from 316-grade stainless steel.

- 5mm countersunk fastening holes.
- Depth: 11mm

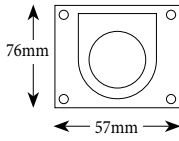

Part No.

JPW19062

### Cupboard Catch - White Nylon

Made from impact-resistant UV-stabilised plastic.



| Part No. | Catch Base L x W (mm) | Post Base L x W (mm) |
|----------|-----------------------|----------------------|
| JPW5493  | 27 x 20               | 24 x 28              |

### Cast Stainless Steel Flush Ring-Pull - Round

316-marine grade stainless steel for long-life performance and durability.

- 5mm countersunk fastening holes.
- Overall depth: 11mm



Part No. Diameter (mm)

JPW19063 50

### Magnetic Door Catch - Stainless Steel

Extremely strong magnet holds door from swinging.

- Cast 316-grade stainless steel.
- Rubber cover for soft close.



| Part No. | Catch Base L x W (mm) | Ball Base L x W (mm) |
|----------|-----------------------|----------------------|
| JPW4687  | 45 x 26               | 34 x 18              |

### Cast Stainless Steel Ring-Pull

Flush mount ring-pull made from 316-grade stainless steel.

- 5mm countersunk fastening holes.
- Depth: 12mm

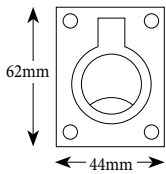

Part No.

JPW19064

### Flush Hatch Cover Pull Stainless Steel

Hatch cover pull commonly used on deck mounted access hatches, engine covers or floor storage.

- Includes stainless steel washer and rubber gasket.



| Part No. | Length (mm) | Stem Dia (mm) | Head Dia (mm) |
|----------|-------------|---------------|---------------|
| JPW19233 | 56          | 6             | 31            |

### Stainless Steel Ring-Pull

Flush mount ring-pull made from 316-grade stainless steel.

- 5mm countersunk fastening holes.
- Depth: 12mm

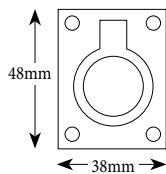

Part No.

JPW19070

### Hatch Holder Springs - Stainless Steel

Holds hatches open and close easily, the ends pivot and rotate for different mounting positions.



| Part No. | Length (mm) |
|----------|-------------|
| JPW19256 | 210         |
| JPW19257 | 260         |

### Cast Stainless Steel Ring-Pull - Heavy Duty

Heavy duty cast 316-grade stainless steel flush mount ring-pull.

- 5mm countersunk fastening holes.
- Depth: 9mm

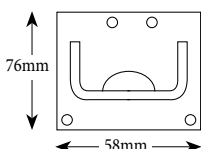

Part No.

JPW19071

**Saddle Eye Straps - Stainless Steel**

316-grade stainless steel saddle eye strap with countersunk fastening holes.



| Part No. | Dimensions L x H (mm) | Fastening Holes (mm) |
|----------|-----------------------|----------------------|
| JPW19166 | 53 x 17               | 2 x 4                |
| JPW19167 | 63 x 20               | 2 x 5                |
| JPW19168 | 67 x 53               | 2 x 6                |

**Grab Handle - Black Nylon**

Non-corrosive nylon grab handle with two 5mm countersunk fastening holes.



| Part No. | Dimensions L x H (mm) |
|----------|-----------------------|
| JPW5425  | 145 x 40              |

**Grab Handle Stainless Steel**

Heavy duty cast 316-grade stainless steel with four 5mm countersunk fastening holes.



| Part No. | Dimensions L x H (mm) |
|----------|-----------------------|
| JPW4725  | 150 x 50              |

**Stud Mount Hand Rails - Black Coated Stainless Steel**

Black PVD coated 316-grade stainless steel hand rail with flange and central stud fixings.

- Includes bolts & washers.



| Part No. | Dimensions L x H (mm) |
|----------|-----------------------|
| JPW4730B | 250 x 60              |
| JPW4731B | 335 x 60              |
| JPW4733B | 490 x 60              |

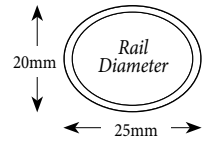

**Stud Mount Hand Rails - Stainless Steel**

Polished 316-grade stainless steel hand rail with flange and central stud fixings.

- Includes bolts & washers.

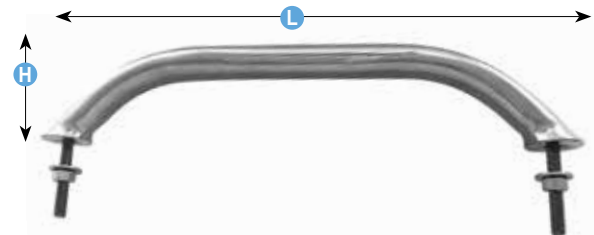

| Part No. | Dimensions L x H (mm) |
|----------|-----------------------|
| JPW4730  | 250 x 60              |
| JPW4731  | 335 x 60              |
| JPW4732  | 440 x 60              |
| JPW4733  | 490 x 60              |

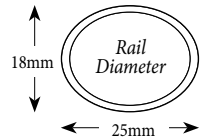

**Stud Mount Hand Rails - Stainless Steel**

Polished 304-grade stainless steel hand rail non-flanged with central stud fixings.

- Includes bolts.



| Part No. | Dimensions L x H (mm) |
|----------|-----------------------|
| JPW4735  | 300 x 50              |
| JPW4736  | 450 x 50              |
| JPW4737  | 600 x 50              |

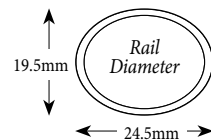

### Slimline Stainless Steel Towel Rail

Add to fibreglass bait boards or install in any other required location.



| Part No. | Length (mm) | Tube (mm) | Screw (mm) |
|----------|-------------|-----------|------------|
| JPW12883 | 487         | 12        | 6          |

### Stud Mount Hand Rail - Stainless Steel



Polished 316-grade stainless steel hand rail supplied with heavy duty stainless steel washers and nyloc bolts.



| Part No. | Length (mm) | Tube (mm) |
|----------|-------------|-----------|
| JPW4734  | 390         | 20        |
| JPW4738  | 900         | 25        |

### Stud Mount Hand Rail with Support Leg - Stainless Steel



Polished 316-grade stainless steel hand rail supplied with heavy duty stainless steel washers and nyloc bolts.

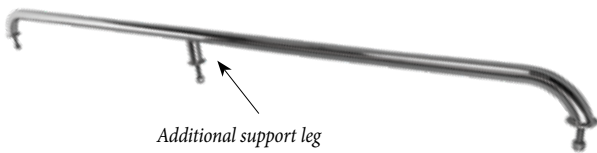

| Part No. | Length (mm) | Tube (mm) |
|----------|-------------|-----------|
| JPW4739  | 1455        | 25        |

### Narva Hand Rail Chrome Polished with LED Light



Fully sealed, water resistant premium hand rail with LED light provides effective illumination matched with sophisticated styling.

**Current Draw:** 0.13A @ 12V

**Voltage:** 12V

**Colour Temp:** 5700°K



| Part No. | Dimensions L x W x H (mm) |
|----------|---------------------------|
| N87605   | 330 x 70 x 45             |



**Folding Drink Holders with Adjustable Extendable Arms**

ABS plastic, mounts easily to any vertical surface and folds up near flat when not in use.

- Adjustable arms extended 75mm to 165mm.
- Protrudes 23mm when folded.



JPW3863

| Part No. | Colour | Dimensions L x W (mm) |
|----------|--------|-----------------------|
| JPW3863  | White  | 95 x 97               |
| JPW3864  | Black  | 95 x 97               |



JPW3864  
Folded Flat

**Folding Drink Holders with Adjustable Flip-up Ring**

ABS plastic, mounts easily to any vertical surface and folds up near flat when not in use.

- Max ring diameter: 85mm.
- Protrudes 23mm when folded.



JPW3865

| Part No. | Colour | Dimensions L x W (mm) |
|----------|--------|-----------------------|
| JPW3865  | White  | 105 x 115             |
| JPW3866  | Black  | 105 x 115             |



JPW3866  
Folded Flat

**Folding Drink Holder - Stainless Steel**

316-grade stainless steel, mounts easily to any vertical surface and folds up near flat when not in use.

- Adjustable arms extended 55mm to 80mm.
- Foam coaster on base.
- Black PVC mouldings and retainers.
- Protrudes out 21mm when closed.



Folded Flat

| Part No. | Dimensions L x W (mm) |
|----------|-----------------------|
| JPW3869  | 102 x 98              |

**Folding Rail Mount Drink Holder - Stainless Steel**

316-grade stainless steel with adjustable arm grips and 360° rail mount bracket suits 25mm rails.

- Adjustable arms extended 55mm to 80mm.
- Foam coaster on base.
- Black PVC mouldings and retainers.
- Protrudes out 21mm when closed.



Folded Flat

| Part No. | Dimensions L x W (mm) |
|----------|-----------------------|
| JPW3873  | 105 x 97              |

**Recessed Drink Holder - Plastic**

Black plastic large recessed cup holder

- Moulded drain outlet to suit 10mm hose.



| Part No. | O.D (mm) | I.D. (mm) | Cut-Out (mm) | Height (mm) |
|----------|----------|-----------|--------------|-------------|
| JPW3867  | 110      | 90        | 92           | 83          |

**Low profile Drink Holder - Stainless Steel**

Slim recessed cup holder perfect for where space is limited.

- Solid base.



| Part No. | O.D (mm) | I.D. (mm) | Cut-Out (mm) | Height (mm) |
|----------|----------|-----------|--------------|-------------|
| JPW3875  | 89       | 72        | 75           | 45          |

**Drink Holder with Drain - Polished Stainless Steel**

Polished 316-grade stainless steel cup holder with rubber base insert.

- Straight drain hose.



| Part No. | O.D (mm) | I.D. (mm) | Cut-Out (mm) | Height (mm) |
|----------|----------|-----------|--------------|-------------|
| JPW3862  | 108      | 90        | 92           | 83          |

**Drink Holder with Drain - Brushed Stainless Steel**

Brushed 316-grade stainless steel cup holder with rubber base insert.

- Foam seal with double sided tape.
- Threaded drain hose.



| Part No. | O.D (mm) | I.D. (mm) | Cut-Out (mm) | Height (mm) |
|----------|----------|-----------|--------------|-------------|
| JPW3868  | 108      | 90        | 92           | 83          |

**Drink Holder Large Plastic Carbon Print with Drain**

Plastic drink holder with carbon print and stepped base to hold a variety of sized drink containers.

- Removable rubber plugged drain with moulded outlet to suit 10mm hose.



| Part No. | O.D (mm) | I.D. (mm) | Cut-Out (mm) | Height (mm) |
|----------|----------|-----------|--------------|-------------|
| JPW3872  | 108      | 88 - 70   | 92           | 86          |

### Drink Holder Large Stainless Steel Powder Coated Black with Drain

304-grade stainless steel with cratch-resistant, glossy black powder coating. The removable rubber plugged drain suits 10mm hose.

- Stepped base to hold a variety of sized drink containers.
- Foam seal with double sided tape.
- **JPW3876:** Blue LED underlighting.



**JPW3876**  
With LED Ring

| Part No.       |                | O.D (mm) | I.D. (mm) | Cut-Out (mm) | Height (mm) |
|----------------|----------------|----------|-----------|--------------|-------------|
| No LED         | With LED       |          |           |              |             |
| <b>JPW3874</b> | <b>JPW3876</b> | 110      | 70 - 88   | 92           | 86          |

### Drink Holder Large Stainless Steel with Drain

316-grade stainless steel with highly polished finish. The removable rubber plugged drain suits 10mm hose.

- Stepped base to hold a variety of sized drink containers.
- Foam seal with double sided tape.
- **JPW3877:** Blue LED underlighting.



**JPW3876**  
With LED Ring

| Part No.       |                | O.D (mm) | I.D. (mm) | Cut-Out (mm) | Height (mm) |
|----------------|----------------|----------|-----------|--------------|-------------|
| No LED         | With LED       |          |           |              |             |
| <b>JPW3859</b> | <b>JPW3877</b> | 110      | 70 - 88   | 92           | 86          |

### Drink Holder Stainless Steel with LED Lights and Drain

Brushed finish stainless steel with rubber base insert and drain.

- Stepped base to hold a variety of sized drink containers.
- Foam seal with double sided tape.
- Blue LED internal lights.



| Part No.       | O.D (mm) | I.D. (mm) | Cut-Out (mm) | Height (mm) |
|----------------|----------|-----------|--------------|-------------|
| <b>JPW3871</b> | 108      | 90        | 92           | 83          |

### Side Mount Ring Drink Holder - Stainless Steel

Stylish ring drink holder made from polished 316-grade stainless steel.

- Side mount plate with two 5mm countersunk fastening holes.



| Part No.       | Height (mm) | Width (mm) | Ring I.D. (mm) |
|----------------|-------------|------------|----------------|
| <b>JPW3858</b> | 110         | 130        | 90             |

### Ring Drink Holders - Stainless Steel

Stylish ring drink holders made from polished 316-grade stainless steel.

- Surface mount.
- Fastens from below with 1/4" thread (screws and washers not included).



| Part No.       | Type   | Height (mm) | Width (mm) | Ring I.D. (mm) |
|----------------|--------|-------------|------------|----------------|
| <b>JPW3860</b> | Single | 70          | 105        | 90             |
| <b>JPW3861</b> | Double | 70          | 210        | 90             |

### STILLA Multifunctional Cup Bottle Holder with Spike

A spill proof cup & bottle holder solution, ideal for securing wine glasses, soda cans, cups, glasses, and more. Mount into cup holders or on top of table posts, or use the included spike to place into the ground.

- Made from 60% recycled fishing ropes, trawls and nets.
- Accommodates up to 5 containers.
- Dishwasher safe.

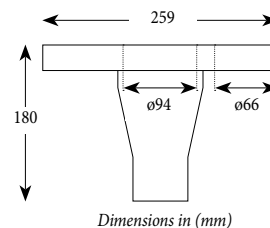

| Part No.       | Suits              |
|----------------|--------------------|
| <b>JPW3855</b> | ø70mm Cup Holder   |
|                | ø60mm Post         |
|                | ø40mm Flat Surface |

**Glove Box - Standard**

Strong, lightweight glove box with stainless steel hinge pins and lock.

- Supplied with pre-installed lock, two keys and four countersunk mounting screws.



JPW5156

| Part No. | Door Size (mm)                | Depth Behind Dash (mm) | Cut-out Size (mm) |
|----------|-------------------------------|------------------------|-------------------|
| JPW5153  | 340 x 140                     | 155                    | 300 x 100         |
| JPW5156  | Replacement Lock and Two Keys |                        |                   |

**Glove Box with Drink Holders**

Lockable glove box with textured finish. Strong quad hinged front cover complete with two folding drink holders.

- Cup holders suit standard cans and bottles and adjust to smaller containers.
- Complete with lock set fitted, two keys and six stainless steel fastening screws.



JPW5156

| Part No. | Door Size (mm)                | Depth Behind Dash (mm) | Cut-out Size (mm) |
|----------|-------------------------------|------------------------|-------------------|
| JPW5154  | 340 x 140                     | 155                    | 300 x 100         |
| JPW5156  | Replacement Lock and Two Keys |                        |                   |

**Storage Hatch Door - Stainless Steel**



Made from 316-grade stainless steel, fully seam welded, hand finished and hand polished to a mirror finish.

- Stainless steel pull handle with integrated lock and keys.
- Flush-mount.



| Part No. | Cut-out W x H (mm) | Overall L x W (mm) |
|----------|--------------------|--------------------|
| JPW12828 | 380 x 290          | 420 x 330          |

**Storage Cases - White ABS Plastic**

A range of white ABS plastic recessed boxes ideal for use as recessed storage pockets in a dry or covered area.

- Can be used for storage, transom shower holders, battery isolator enclosure and a variety of other uses.



JPW1260

JPW1263

JPW1259

| Part No. | Type        |
|----------|-------------|
| JPW1259  | Open Pocket |
| JPW1260  | Open        |
| JPW1263  | With Door   |

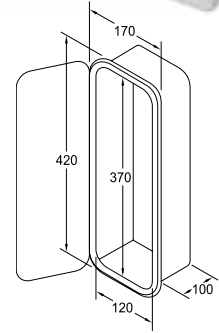

(Dimensions in mm)



JPW1261

JPW1264

| Part No. | Type      |
|----------|-----------|
| JPW1261  | Open      |
| JPW1264  | With Door |

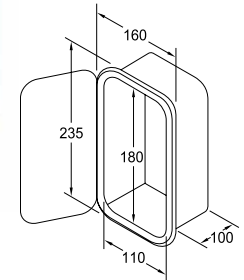

(Dimensions in mm)



JPW1262

JPW1265

| Part No. | Type      |
|----------|-----------|
| JPW1262  | Open      |
| JPW1265  | With Door |

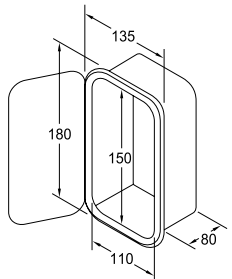

(Dimensions in mm)



| Part No. | Type         |
|----------|--------------|
| JPW1266  | Open Tapered |

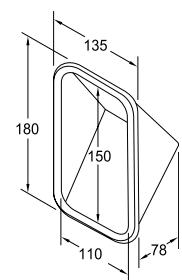

(Dimensions in mm)

### Osculati Premium Flush Access Storage Hatches

Made from UV-resistant ABS plastic material, these hatches feature faired cover that hides the frame completely and have flat hinges to create a fully flush finish.

- Can be used for storage, access, or inspection.
- 180° opening with pre-drilled countersunk fastening holes.
- Walking surface, mount vertically or horizontally.
- UV resistant & splashproof (not 100% waterproof).



SPX17051 / 52 / 53  
Replacement Hinges



SPX17045  
Optional lock kit



380 x 280mm



375 x 375mm



520 x 465mm

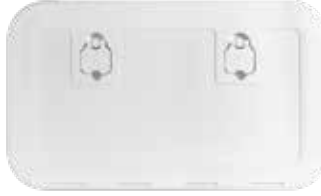

600 x 350mm



600 x 250mm

| Part No.  |           |           | Overall LxW (mm) | Cut-out LxW (mm) | Opening LxW (mm) |
|-----------|-----------|-----------|------------------|------------------|------------------|
| White     | Black     | Grey      |                  |                  |                  |
| JPW170457 | JPW170458 | JPW170459 | 380 x 280        | 310 x 210        | 295 x 198        |
| JPW170467 | JPW170468 | JPW170469 | 375 x 375        | 300 x 300        | 285 x 285        |
| JPW170472 | JPW170473 | JPW170474 | 520 x 465        | 445 x 390        | 430 x 375        |
| JPW170462 | JPW170463 | JPW170464 | 600 x 350        | 530 x 280        | 513 x 265        |
| JPW170477 | JPW170478 | JPW170479 | 600 x 250        | 530 x 180        | 515 x 165        |



Black

Grey

### Osculati Classic Access Storage Hatches

Made from UV-resistant ABS plastic material, these hatches feature an anti-slip lid surface and flush hinges.

- Perfect for lockers, fishing tanks, storerooms or bulkheads.
- 160° opening with pre-drilled countersunk fastening holes.
- Walking surface, mount vertically or horizontally.
- UV resistant & splashproof (not 100% waterproof).

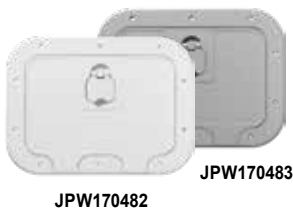

JPW170482

JPW170483



SPX17045  
Optional lock kit



JPW170482

JPW170483



SPX17055 / 56  
Replacement Hinges

| Part No.  |           | Outside LxW (mm) | Cut-out LxW (mm) | Opening LxW (mm) |
|-----------|-----------|------------------|------------------|------------------|
| White     | Grey      |                  |                  |                  |
| JPW170482 | JPW170483 | 380 x 280        | 315 x 215        | 280 x 180        |
| JPW170485 | JPW170486 | 595 x 345        | 525 x 280        | 500 x 250        |

### Osculati Access Hatches with Box

Made from UV-resistant ABS plastic material, these all-in-one hatches come fitted complete with a durable built-in locker box.

- Perfect for lockers, storerooms or bulkheads.
- Pre-drilled countersunk fastening holes.
- Walking surface, mount vertically or horizontally.
- UV resistant & splashproof (not 100% waterproof).
- CE Approved (UNI EN ISO 12216:2004).

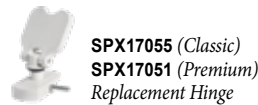

SPX17055 (Classic)  
SPX17051 (Premium)  
Replacement Hinge



SPX17045  
Optional lock kit



JPW170488  
Classic



JPW170489  
Premium

| Part No.  |           | Overall LxW (mm) | Cut-out LxW (mm) | Opening LxW (mm) |
|-----------|-----------|------------------|------------------|------------------|
| Premium   | Classic   |                  |                  |                  |
| JPW170488 | JPW170489 | 380 x 280        | 315 x 215        | 280 x 180        |

**Blower Vents - ABS Plastic**

Louvre ventilators made from ABS plastic with a hose tail end for connection to 75mm bilge blower exhaust outlet hose.

- Four 8mm countersunk fastening holes.



| Part No. | Colour | Dimensions L x W x H (mm) |
|----------|--------|---------------------------|
| JPW1237  | White  | 90 x 90 x 50              |
| JPW1238  | Black  | 90 x 90 x 50              |

**Flush Mount Vents - Nylon**

ABS plastic flush mount louvre vents.

- Suitable for lockers, doors, cupboards, etc.
- Four 8mm countersunk fastening holes.



| Part No. | Colour | Dimensions L x W (mm) |
|----------|--------|-----------------------|
| JPW1239  | White  | 85 x 85               |
| JPW1240  | Black  | 85 x 85               |

**6 Louvre Vents - ABS Plastic**

Strong UV-stabilised ABS plastic vents with rounded corners.

- Six 5mm countersunk fastening holes.



| Part No. | Colour | Dimensions L x H (mm) |
|----------|--------|-----------------------|
| JPW1230  | Black  | 260 x 125             |
| JPW1231  | White  | 260 x 125             |

**Louvre Vents with Serration - Nylon**

UV-resistant nylon with a serration across the centre so it can be made into two smaller vents (2x 6 louvres per vent).

- Twelve 8mm countersunk fastening holes.



| Part No. | Colour | Dimensions L x H (mm) |
|----------|--------|-----------------------|
| JPW1235  | White  | 256 x 118             |
| JPW1236  | Black  | 256 x 118             |

**Louvre Vents - Stainless Steel**

Made from pressed 316-grade stainless steel with a mirror-polished surface and low-profile design for a slimline look.

- 1mm thick plate.

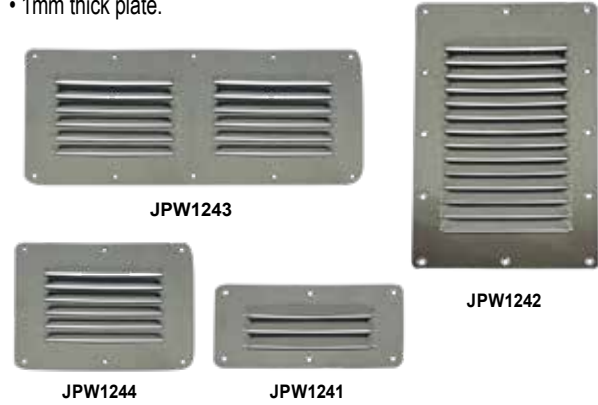

| Part No. | No. Louvres | Dimensions L x W (mm) | Fastening Holes |
|----------|-------------|-----------------------|-----------------|
| JPW1241  | 3           | 127 x 65              | 6 x 4mm         |
| JPW1242  | 14          | 127 x 227             | 12 x 4.5mm      |
| JPW1243  | 12          | 232 x 115             | 10 x 4mm        |
| JPW1244  | 6           | 127 x 115             | 6 x 4mm         |

**V Style Louvre Vents - Stainless Steel**

304-grade stainless steel durable V-style vents.



| Part No. | No. Louvres | Dimensions L x W (mm) |
|----------|-------------|-----------------------|
| JPW1248  | 4           | 265 x 112 x 26        |
| JPW1249  | 5           | 327 x 112 x 26        |

**Flat Style Louvre Vent - Stainless Steel**

316-grade stainless steel durable flat top style vent.



| Part No. | No. Louvres | Dimensions L x W (mm) |
|----------|-------------|-----------------------|
| JPW1254  | 10          | 527 x 76 x 26         |

**Mini Clam Vents - Stainless Steel**

Commonly used as anchor well drain covers or for covering thru-transom wiring connections.

- Pressed 316-grade stainless steel.



| Part No. | Dimensions L x W x H (mm) | Fastening Holes (mm) |
|----------|---------------------------|----------------------|
| JPW1245  | 43 x 42 x 10              | 3 x 3                |
| JPW1246  | 57 x 55 x 13              | 3 x 3.75             |

### Scanstrut ROKK Mini Separate Mounts

Compact and multi-adjustable mounting system for smartphones, handheld GPS and other small devices up to 1.2kg.

- Each part sold separately.



1 JPW10472 Phone Clamp

2 JPW10485 Adjustable Body



3 JPW10481

3 JPW10482

3 JPW10483

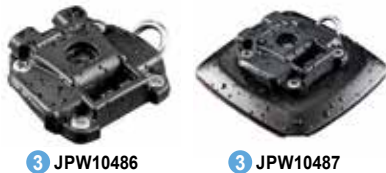

3 JPW10486

3 JPW10487

| Part No. | Description           | Suits / Application            |
|----------|-----------------------|--------------------------------|
| JPW10472 | Phone Clamp Top Plate | Device size 45-95mm            |
| JPW10485 | 360° Adjustable Body  | Up to 1.2kg                    |
| JPW10481 | Rail Mount Base       | 19-34mm diameter rails         |
| JPW10482 | Cable Tie Base        | 60-100mm diameter              |
| JPW10483 | Suction Cup Base      | Clean, non-textured surface    |
| JPW10484 | Kayak Track Base      | All major kayak track profiles |
| JPW10486 | Screw Down Base       | Any surface                    |
| JPW10487 | Self-Adhesive Base    | Any clean flat surface         |

### Scanstrut Scanpods Deck Mounts

Install your multi-function display device on virtually on any flat surface on board. UV and heat resistant seals made from high tear strength silicone.

- 360° viewing angle swivel and tilt base.
- Added strength with inner bracing plate.
- Overhead mounting optional.
- Supplied uncut.

Other sizes and mounting options available - contact us for more information.

| Part No. | L x W x D (mm)  |
|----------|-----------------|
| JPW10519 | 324 x 228 x 167 |
| JPW10520 | 374 x 243 x 167 |
| JPW10521 | 392 x 286 x 167 |
| JPW10522 | 409 x 287 x 167 |
| JPW10523 | 482 x 396 x 175 |



### Scanstrut ROKK Mini Tablet Mount Kits

A tough, compact and multi-adjustable mounting systems for tablets, small fish finders and other digital devices.

- Secure metal-on-metal locking system.
- For devices up to 1.2kg.
- Tough, marine-grade, UV stable materials.
- Smaller clamp (for phones) and alternative mounts are available - see separate parts opposite.

#### Kits Include:

- 1 Ratchet adjustable tablet clamp top plate (fits devices 125-220mm).
- 2 360-degree adjustable aluminium body.
- 3 Screw down, rail mount or suction cup base.



| Part No. | Base Type        |
|----------|------------------|
| JPW10476 | Screw Down Base  |
| JPW10477 | Rail Mount Base  |
| JPW10480 | Suction Cup Base |

### Scanstrut Scanpods Helm Rail Mounts

The saddle system supports the stainless tubing enabling a secure and rigid fit onto pedestal rails from 25mm to 33.7mm diameter.

- UV and heat resistant seals made from high tear strength silicone.
- Secure and watertight installation.
- No drill fixing kit included.
- Supplied uncut.

Other sizes and mounting options available - contact us for more information.

| Part No. | L x W x D (mm)  |
|----------|-----------------|
| JPW10524 | 324 x 228 x 167 |
| JPW10525 | 374 x 243 x 167 |
| JPW10527 | 409 x 287 x 167 |
| JPW10528 | 467 x 387 x 183 |



**Bow Rollers - Polyurethane**

To suit bow sprits, these outlast conventional rollers, are less abrasive and reduce any noise when in use.

- Made from hard-wearing red polyurethane.
- Suitable for fibreglass hulls.

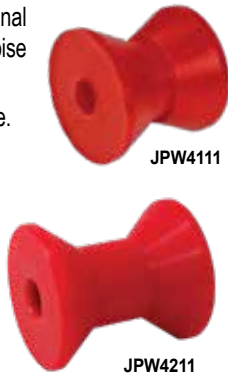
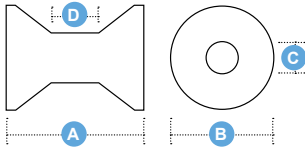

| Part No. | Type          | Dimensions (mm) |    |    |    |
|----------|---------------|-----------------|----|----|----|
|          |               | A               | B  | C  | D  |
| JPW4111  | 2" Bow Roller | 50              | 50 | 13 | 13 |
| JPW4211  | 3" Bow Roller | 75              | 70 | 17 | 27 |

**Bow Rollers - Polyethylene**

Hard durable, high density polyethylene (HDPE) rollers are lightweight and impact resistant. High quality and notably quiet.

- Suitable for aluminium hulls.

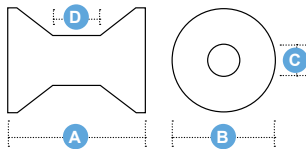

| Part No. | Colour | Dimensions (mm) |    |    |    |
|----------|--------|-----------------|----|----|----|
|          |        | A               | B  | C  | D  |
| JPW4213  | Red    | 74              | 70 | 17 | 27 |
| JPW4214  | Blue   | 74              | 70 | 17 | 27 |

**Viper Pro Deluxe Anchor Rollers**

316-grade stainless steel anchor rollers made from 5mm plate, hand polished to a mirror finish.

- Stainless steel bolts, nuts and washers provided.
- 2x 8mm pre-drilled mounting holes.

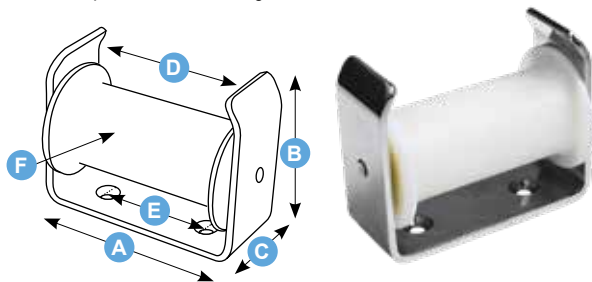

| Part No. | Type  | Dimensions (mm) |     |    |     |     |    |
|----------|-------|-----------------|-----|----|-----|-----|----|
|          |       | A               | B   | C  | D   | E   | F  |
| JPW12834 | Small | 130             | 105 | 50 | 100 | 70  | 53 |
| JPW12835 | Large | 205             | 105 | 50 | 175 | 105 | 53 |

**Small Bow Roller - Aluminium**

Small bow roller made from cast aluminium.

- Suitable as a weld-on bow roller for aluminium boats.

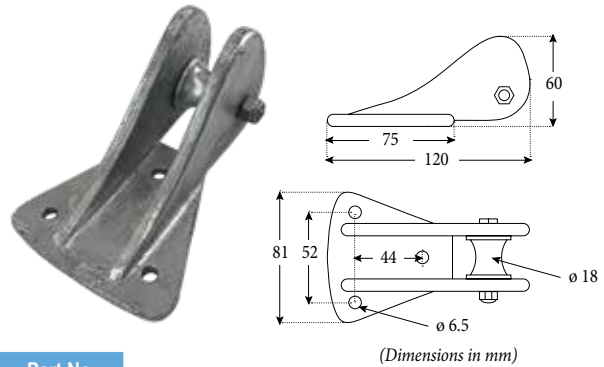

|          |         |
|----------|---------|
| Part No. | JPW4220 |
|----------|---------|

**Small Bow Roller - Stainless Steel**

Small 304-grade heavy duty stainless steel fixed bow roller.

- Three 9.5mm fixing holes and black roller.

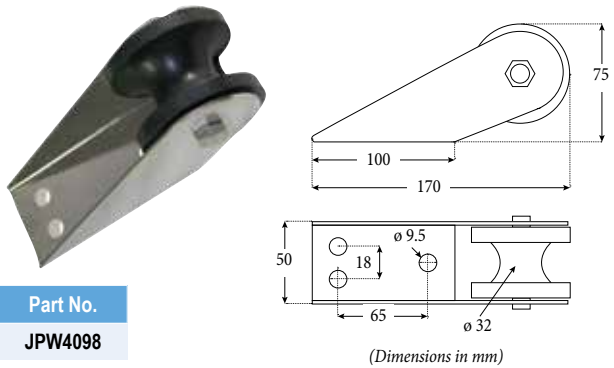

|          |         |
|----------|---------|
| Part No. | JPW4098 |
|----------|---------|

**Cast Stainless Steel Bow Rollers**

Cast 316-grade stainless steel bow rollers finished to a high polish.

- Saddle strap to retain anchor and rode during recovering anchor.
- Designed for use with Danforth anchors, Delta/Fixed Head anchors, Plough anchors and Claw anchors.

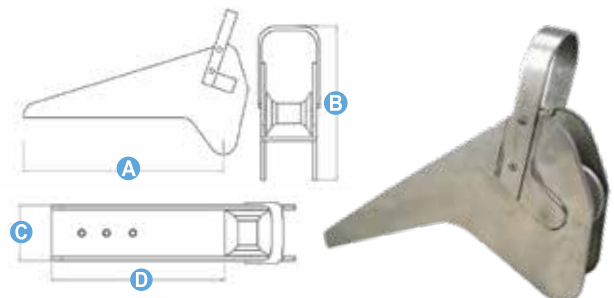

| Part No. | Suits Anchor Size (kg) | Dimensions (mm) |     |    |     |
|----------|------------------------|-----------------|-----|----|-----|
|          |                        | A               | B   | C  | D   |
| JPW4221  | 10                     | 380             | 196 | 67 | 261 |
| JPW4222  | 15                     | 480             | 240 | 75 | 300 |
| JPW4223  | 20                     | 590             | 235 | 78 | 340 |
| JPW4224  | 30                     | 590             | 240 | 78 | 340 |

### Bow Roller - Stainless Steel

316-grade stainless steel bow roller with spring loaded removable retaining pin and single stainless steel roller assembly

- Highly polished finish.

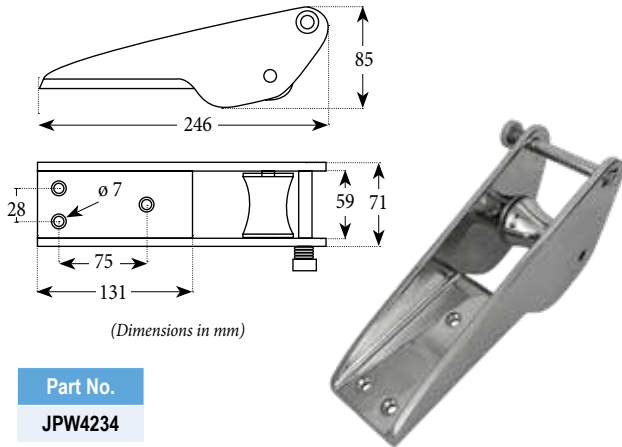

Part No.  
JPW4234

### Bow Roller - Stainless Steel

316-grade stainless steel bow roller with brushed finish.

- Spring loaded retaining pin
- Single roller assembly.

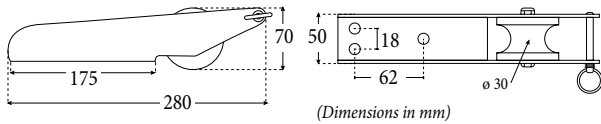

| Part No. | Dimensions (mm) |     |     |    |    |    |    |
|----------|-----------------|-----|-----|----|----|----|----|
|          | A               | B   | C   | D  | E  | F  | G  |
| JPW4099  | 70              | 280 | 175 | 50 | 30 | 62 | 18 |

### Self-Launching Bow Rollers - Stainless Steel

Heavy duty marine-grade stainless steel. Designed for use with Delta/Fixed Head anchors and Rocna Original, Vulcan and Fisherman anchors.

- 2x white anchor guide rollers.
- Suit rope size 6mm or larger.

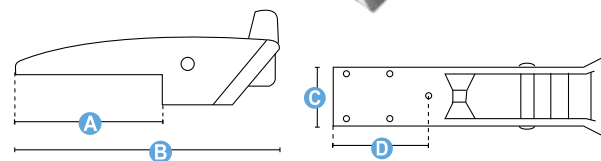

| Part No. | Dimensions (mm) |     |    |     | Suits Anchor Size (kg) |       |           |
|----------|-----------------|-----|----|-----|------------------------|-------|-----------|
|          | A               | B   | C  | D   | Delta                  | Rocna | Fisherman |
| JPW4231  | 225             | 415 | 76 | 150 | 6-10                   | 4-6   | 4-6       |
| JPW4232  | 390             | 585 | 80 | 265 | 10                     | 4-10  | 4         |

### Viper Pro Deluxe Single Bow Roller



Made from 5mm 316-grade stainless steel, this roller is self-launching and suitable to fit almost any anchor. Allows for free falling, correct alignment upon retrieval and reduces rope chafe.

- Stainless steel bolts, nuts and washers provided.
- 4x 8mm pre-drilled mounting holes.
- Polished to a mirror finish.
- Single roller assembly.

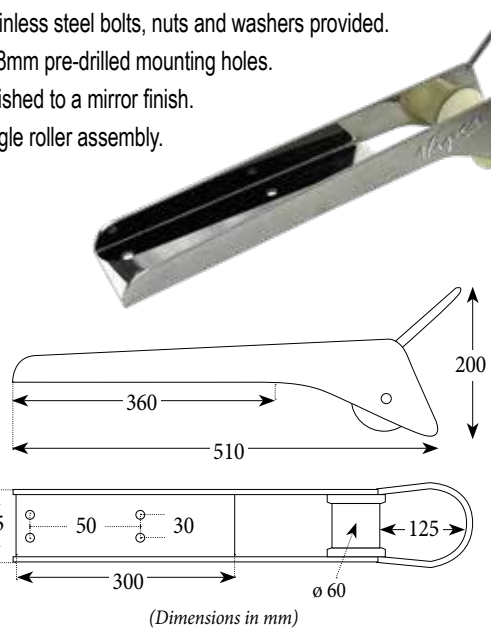

Part No.  
JPW12832

### Viper Pro Deluxe 3 Roller Bow Rollers



Self-launching and designed to fit most plough anchors. Made from 5mm plate 316-grade stainless steel, polished to a mirror polish.

- Safety loop to stop rope from sliding over.
- 3x high performance nylon rollers.
- 4x 8mm pre-drilled mounting holes.

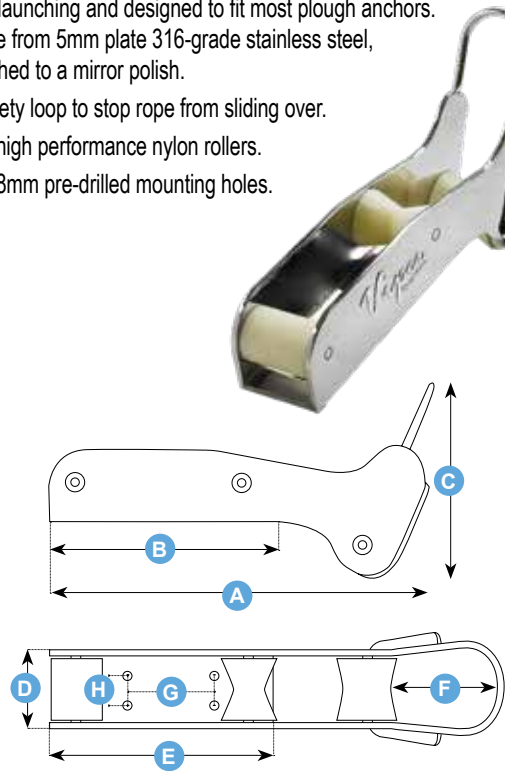

| Part No. | Dimensions (mm) |     |     |    |     |     |     |    |
|----------|-----------------|-----|-----|----|-----|-----|-----|----|
|          | A               | B   | C   | D  | E   | F   | G   | H  |
| JPW12830 | 370             | 240 | 210 | 70 | 210 | 153 | 90  | 30 |
| JPW12831 | 495             | 290 | 255 | 95 | 350 | 182 | 175 | 42 |

## Cross Bollards - Aluminium

Cross bollards made from cast marine-grade aluminium alloy.

- Can be welded and fastened to deck or drilled out and screwed into position.



| Part No. | Base Dimensions L x W (mm) | Height (mm) |
|----------|----------------------------|-------------|
| JPW4247  | 60 x 60                    | 76 (3")     |
| JPW4248  | 88 x 75                    | 100 (4")    |
| JPW4249  | 88 x 88                    | 155 (6")    |

## Cross Bollard - Aluminium

Australian made cast marine-grade aluminium bollards that can be welded or fastened to a deck.

- 8mm thick base.



| Part No. | Base Dimensions L x W (mm) | Height (mm) |
|----------|----------------------------|-------------|
| JPW4250  | 97 x 73                    | 100 (4")    |

## Cross Bollard - Stainless Steel

Heavy duty 316-grade stainless steel cross bollard, designed to fit on most small to large boats.

- Polished finish for a great looking shine.
- Four 4.5mm fastening holes.



| Part No. | Base Dimensions L x W (mm) | Height (mm) |
|----------|----------------------------|-------------|
| JPW4252  | 60 x 60                    | 80 (3")     |

## Horn Bollards - Stainless Steel

Quality mirror-polished 316-grade stainless steel bolt-thru style, attached from underneath the cleat.

- Ideal for larger yachts and cruisers.
- Robust construction for the use of large ropes.
- Use as a fairlead or stern chock.



| Part No. | Base Dimensions L x W (mm) | Height (mm) | Hole Centres (mm) | Max Rope Dia (mm) |
|----------|----------------------------|-------------|-------------------|-------------------|
| JPW4243  | 158 x 58                   | 60          | 70                | 45                |
| JPW4244  | 200 x 68                   | 66          | 80                | 60                |
| JPW4245  | 233 x 70                   | 80          | 90                | 60                |

## Split Bollards

Cast 316-grade stainless steel split bollards with or without pin, allows for securing the chain into the bollard.

- Polished finish and gentle rake.



JPW4215



JPW4216

| Part No. |          | Base L x W (mm) | Height (mm) | Chain Size (mm) |
|----------|----------|-----------------|-------------|-----------------|
| No Pin   | With Pin |                 |             |                 |
| JPW4215  | JPW4216  | 60 x 60         | 84          | 8 - 10          |

## Fairleads Straight (Bow Chock) - Stainless Steel

- Cast 316-grade stainless steel with a highly polished finish.
- Two 6mm fastening holes.
- Sold individually.



| Part No. | Dimensions L x W (mm) | Hole Centres (mm) | Suits Rope Size (mm) |
|----------|-----------------------|-------------------|----------------------|
| JPW19019 | (5") 127 x 25         | 103               | 16                   |
| JPW19022 | (6") 152 x 25         | 130               | 19                   |

## Fairleads Stainless Steel (Bow Chock)

Cast 316-grade stainless steel fairleads.

- Sold as pair - port and starboard.



| Part No. | Dimensions L x W x H (mm) | Hole Centres (mm) | Suits Rope Size (mm) |
|----------|---------------------------|-------------------|----------------------|
| JPW19025 | (6") 150 x 34 x 32        | 125               | 14                   |
| JPW19026 | (8") 200 x 38 x 38        | 165               | 16                   |
| JPW19027 | (10") 250 x 48 x 40       | 210               | 18                   |

## Fairleads Heavy Duty Solid Base - Stainless Steel

Cast 316-grade stainless steel fairleads, sold as a pair.

- 6mm countersunk fastening holes.



| Part No. | Overall Length (mm) | Max Rope Dia (mm) |
|----------|---------------------|-------------------|
| JPW19023 | 152                 | 19                |

### Small Low-Profile Cleats - Stainless Steel

Cast 316-grade stainless steel, corrosion-resistant, open-base deck cleat.

- Four 6mm countersunk fastening holes.



| Part No. | Top L x H (mm) | Base L x W (mm) | Hole Centres (mm) |
|----------|----------------|-----------------|-------------------|
| JPW19038 | (4") 100 x 25  | 42 x 35         | 30 x 25           |
| JPW19039 | (5") 125 x 28  | 57 x 47         | 41 x 30           |

### Large Low-Profile Cleats - Stainless Steel

- Cast 316-grade stainless steel, highly polished cleat.
- Four 6mm countersunk fastening holes.



| Part No. | Dimensions L x H (mm) | Hole Centres (mm) |
|----------|-----------------------|-------------------|
| JPW19040 | (6") 150 x 30         | 50 x 42           |
| JPW19041 | (8") 200 x 38         | 57 x 41           |
| JPW19042 | (10") 250 x 42        | 57 x 46           |
| JPW19044 | (12") 300 x 55        | 95 x 50           |

### Slimline Cleats - Stainless Steel

Cast 316-grade stainless steel slimline bar, open base deck cleat.

- Four hole mounting positions.



| Part No. | Dimensions L x H (mm) | Hole Centres (mm) |
|----------|-----------------------|-------------------|
| JPW19028 | (4") 100 x 25         | 48 x 22           |
| JPW19029 | (5") 125 x 26         | 55 x 25           |
| JPW19030 | (6") 150 x 30         | 55 x 26           |
| JPW19031 | (8") 200 x 35         | 75 x 28           |
| JPW19032 | (10") 250 x 45        | 95 x 44           |

### Heavy Duty Cleats - Stainless Steel

Cast 316-grade stainless steel and countersunk mounting holes.



| Part No. | Dimensions L x H (mm) | Hole Centres (mm) | Mount Holes ø (mm) |
|----------|-----------------------|-------------------|--------------------|
| JPW19043 | (8") 200 x 35         | 73 x 35           | 7                  |
| JPW19033 | (10") 250 x 42        | 95 x 46           | 8.5                |
| JPW19034 | (12") 300 x 48        | 100 x 51          | 8.5                |

### Cleats with Oval Tube - Stainless Steel

Surface mounted oval tube cleats made from 316-grade stainless steel with a highly polished mirror finish.

- Bolt-thru style attached from underneath (bolts not supplied).



| Part No. | Top L x H (mm) | Base L x W (mm) | Bolt Size | Hole Centres (mm) |
|----------|----------------|-----------------|-----------|-------------------|
| JPW19058 | 150 x 45       | 90 x 31         | M8        | 47                |
| JPW19059 | 200 x 58       | 120 x 35        | M10       | 69                |
| JPW19060 | 250 x 80       | 160 x 50        | M16       | 84                |

### Heavy Duty Weld-On Cleats - Aluminium

Weld-on base cleat available in three sizes.

- Designed for the OEM boat builder and long-life service.



| Part No. | Top L x W x H (mm)    | Base L x W (mm) |
|----------|-----------------------|-----------------|
| JPW5221  | (8") 200 x 28 x 45    | 90 x 58         |
| JPW5215  | (10") 250 x 36 x 60   | 112 x 74        |
| JPW5216  | (12") 300 x 38 x 70   | 129 x 87        |
| JPW5217  | (13.5") 360 x 47 x 80 | 152 x 102       |

### Dock Cleats - Cast Aluminium

Heavy duty alloy dock cleats for marinas, wharves, pontoons, etc.

- Solid weld-on base with large opening for mooring ropes.
- Two 13mm fastening holes.



| Part No. | Top L x H (mm) | Base L x W (mm) | Hole Centres (mm) |
|----------|----------------|-----------------|-------------------|
| JPW4241  | 290 x 90       | 180 x 45        | 105               |
| JPW4242  | 350 x 105      | 200 x 72        | 125               |



### Star Cleat with Studs - Stainless Steel

Cast 316-grade stainless steel 'STAR' deck cleat with 8mm threaded stud mounting rods.

- Supplied with nuts and washers.



| Part No. | Dimensions L x H (mm) | Hole Centres (mm) |
|----------|-----------------------|-------------------|
| JPW19056 | (8") 200 x 50         | 95                |

### Flush Pull-Up Cleats - Stainless Steel

Polished 316-grade stainless steel cleat.

- Pulls up from base and sits almost flush on deck when not in use.

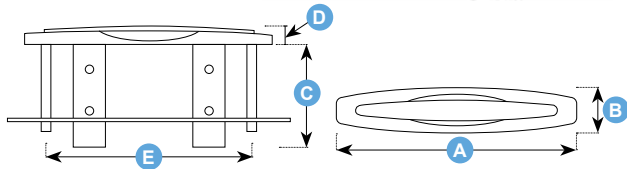

| Part No. | Dimensions (mm) |    |    |    |     |
|----------|-----------------|----|----|----|-----|
|          | A               | B  | C  | D  | E   |
| JPW19013 | 125             | 31 | 50 | 10 | 97  |
| JPW19014 | 150             | 31 | 62 | 10 | 125 |
| JPW19015 | 200             | 46 | 83 | 14 | 155 |

### Flush Pull-Up Cleats - Polished Stainless Steel

Surface mounted cleat made from 316-grade stainless steel with a highly polished mirror finish.

- Pulls up from base and sits almost flush on deck when not in use.
- Strong stainless steel mounting bolts sit below deck.

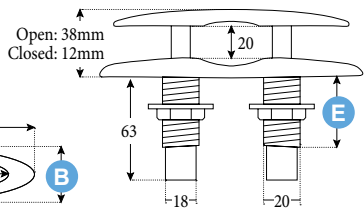

| Part No. | Dimensions (mm) |    |     |      |    |
|----------|-----------------|----|-----|------|----|
|          | A               | B  | C   | D    | E  |
| JPW19011 | 127             | 32 | 107 | 16.5 | 42 |
| JPW19012 | 150             | 36 | 136 | 18   | 44 |

### Folding Cleats - Stainless Steel

Heavy-duty cast 316-grade stainless steel low profile folding cleat.

- Indented finger lift for easy retrieval, simply push to fold away to create a flush profile.



| Part No. | L x W (mm) | Height Closed (mm) | Height Open (mm) | Mounting Hole Ø (mm) |
|----------|------------|--------------------|------------------|----------------------|
| JPW19050 | 155 x 54   | 13.5               | 47               | 8                    |
| JPW19051 | 202 x 72   | 15                 | 62               | 8                    |

### Lifting Ring 150mm Cleat - Stainless Steel

Polished 316-grade stainless steel 150mm cleat with a 25mm hole for securely lifting or tying off.

- Secure by screw down or via internal threaded rod.



| Part No. | Length (mm) | Eye Ø (mm) | Hole Cut-Out Ø (mm) | Base Ø (mm) | Internal Thread (mm) |
|----------|-------------|------------|---------------------|-------------|----------------------|
| JPW19045 | 150         | 25         | 25                  | 47          | 15 (UNC)             |

### Cleats Black Nylon

Featuring a flat base and two central fastening holes through the cleat posts.



| Part No. | Top L x W (mm) | Base L x W (mm) | Height (mm) | Hole Centres (mm) |
|----------|----------------|-----------------|-------------|-------------------|
| JPW5523  | 100 x 14       | 54 x 14         | 20          | 28                |
| JPW5524  | 125 x 17       | 64 x 18         | 30          | 36                |
| JPW5525  | 150 x 22       | 75 x 22         | 35          | 42                |
| JPW5526  | 200 x 24       | 84 x 23         | 40          | 48                |

### Rub Strake - Stainless Steel

Highly polished 316-grade stainless steel strake prevents chafing of ropes and provides reliable protection to the boat's gelcoat or paint.

- Slim design with pre-drilled holes (5mm).
- Sold individually.



| Part No. | Dimensions L x W (mm) |
|----------|-----------------------|
| JPW9902  | 304 x 19              |
| JPW9903  | 457 x 19              |
| JPW9904  | 610 x 19              |

### Aluminium Scuppers

High quality aluminium alloy transom drain scuppers or ventilators.

- Spring-loaded with strong stainless spring and watertight sealing gasket.
- Ideal vents for draining the deck of your boat, air pressurising your caravan, van body, or as a vent to allow air to flow in.
- Repair service kits also available.



**JPW4261 / JPW4271**  
White Powder Coated

**JPW4260 / JPW4270**  
Plain Aluminium

| Part No. | Type                | Size  | L x W (mm) |
|----------|---------------------|-------|------------|
| JPW4260  | Plain Aluminium     | Small | 167 x 112  |
| JPW4261  | White Powder Coated | Small | 167 x 112  |
| JPW4270  | Plain Aluminium     | Large | 240 x 147  |
| JPW4271  | White Powder Coated | Large | 240 x 147  |

### Aluminium Scupper Repair Kits

Kits contains 1x foam seal and 1x spring.

- Suits Aluminium Scuppers above.



Large Spring

Small Spring

Foam Seal

| Part No. | Type                 | Suits Scupper Size |
|----------|----------------------|--------------------|
| JPW4272  | Foam Seal and Spring | Small              |
| JPW4273  | Foam Seal and Spring | Large              |
| JPW4279  | Spare Spring only    | Small              |



### Plastic Nylon Scuppers

Spring-loaded with strong stainless spring and watertight sealing gasket.

- Ideal vents for draining the deck of your boat, air pressurising your caravan, or as a vent to allow air to flow in.



**JPW6262 / JPW6264**  
Black

**JPW6263 / JPW6265**  
White

| Part No. |                            | Dimensions L x W (mm) |
|----------|----------------------------|-----------------------|
| White    | Black                      |                       |
| JPW6263  | JPW6262                    | 175 x 120             |
| JPW6265  | JPW6264                    | 240 x 147             |
| JPW6261  | Replacement scupper spring |                       |

### Water Scoop Bracket for Live Bait Tanks

316-grade stainless steel, solidly constructed bracket ideal for circulating fresh sea water through your bait tank while under way.

- Suits 12mm hose.
- Australian made.



| Part No. | Suits Hose  |
|----------|-------------|
| JPW3805  | 12mm (1/2") |
| JPW3804  | 19mm (3/4") |

### Water Scoop Bilge Pump Bracket for Live Bait Tanks

316-grade stainless steel bilge pump bracket with water scoop, for circulating fresh sea water through your bait tank while under way or stationary.

- Suits old and new Rule 360 and 500 bilge pumps.
- 'U' shaped clamp to hold pump in place.



\*Pump not included

| Part No. |
|----------|
| JPW3806  |

**Recess Fuel Breathers - Stainless Steel**

Provides a flush to hull installation, or surface mount installation by removing the flush mount "cup" and reversing the backing plate.

- Made of cast 316-grade stainless steel.
- Suitable for all types of hull material.

| Part No. | Suits Hose (mm) | Type      |
|----------|-----------------|-----------|
| JPW19153 | 16              | 90° Angle |
| JPW19154 | 16              | Straight  |



**Deck Fillers - Nylon**

Universal type fillers featuring a quick and easy opening cap with 'O' ring seal and stainless steel safety chain.

- Includes stick-on name plates (Water, Waste, Petrol, Diesel, Fuel and Gas).

| Part No. | Hose Size (mm) |
|----------|----------------|
| JPW2628  | 38             |
| JPW2629  | 50             |



**Recess Fuel Breather - Stainless Steel**

316-grade stainless steel recessed fuel breather vent with a 90 degree angled barb.

- Suits hulls up to 38mm thick.
- Additional flange for thinner hulls (3.5mm).

| Part No.  |           | Suits Hose (mm) |
|-----------|-----------|-----------------|
| Stainless | Black PVD |                 |
| JPW19126  | JPW19126  | 16              |



**Deck Fill Stainless Steel with Vent FUEL 38mm**

Heavy duty cast 316 grade stainless steel deck fill with breather vent and FUEL identification stamped into the highly polished top.

- Suits 16mm breather hose.

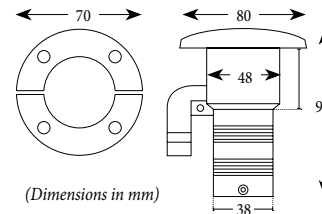

| Part No. | Hose Size (mm) |
|----------|----------------|
| JPW19268 | 38             |

**Fuel Breather Vent - Stainless Steel**

316-grade stainless steel fuel breather vent, slightly recessed with a straight barb.

| Part No. | Suits Hose (mm) |
|----------|-----------------|
| JPW19124 | 19              |



**Opening Key Deck Fillers - Stainless Steel**

High quality heavy duty cast 316-grade stainless steel deck fillers.

- Supplied complete with stainless steel retaining chain, 'O' ring seal and key.

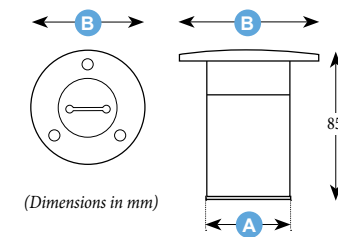

**Fuel Breathers - Stainless Steel**

316-grade stainless steel with a round head, suitable for all types of hull material.

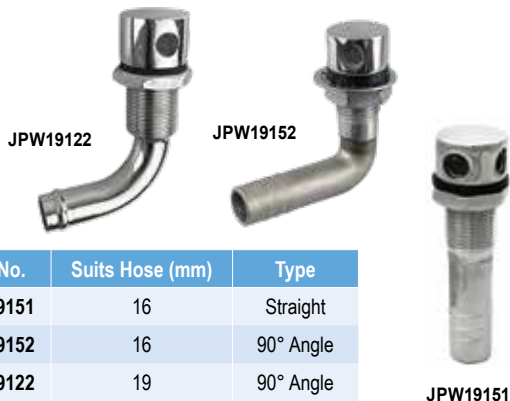

| Part No. | Suits Hose (mm) | Type      |
|----------|-----------------|-----------|
| JPW19151 | 16              | Straight  |
| JPW19152 | 16              | 90° Angle |
| JPW19122 | 19              | 90° Angle |

| Part No.  | Type  | Dimensions (mm) |           |
|-----------|---|-----------------|-----------|
|           |   | Hose Size (A)   | Rim Ø (B) |
| JPW19090F | Fuel  | 38              | 75        |
| JPW19093F | Fuel  | 50              | 80        |
| JPW19090  | Petrol                                      | 38              | 75        |
| JPW19093  | Petrol                                      | 50              | 80        |
| JPW19091  | Diesel                                      | 38              | 75        |
| JPW19096  | Diesel                                      | 50              | 80        |
| JPW19092  | Water                                       | 38              | 75        |
| JPW19098  | Water                                       | 50              | 80        |
| JPW19094  | Waste                                       | 38              | 75        |
| JPW19097  | Waste                                       | 50              | 80        |
| JPW19099  | Spare Deck Fill Key 38 & 50mm deck fillers. |                 |           |

### Keyless Deck Fillers - Stainless Steel

Flush mount cast 316-grade stainless deck fillers with a flip-up key to ensure easy removal. Features coarse thread, 'O' ring seal, retaining chain and filler type identification moulded into the lid.

- 4mm countersunk fastening holes.

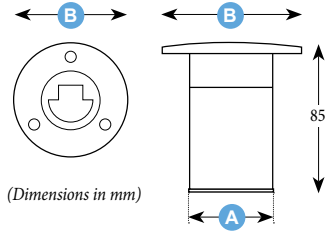

| Part No. | Type   | Dimensions (mm) |           |
|----------|--------|-----------------|-----------|
|          |        | Hose Size (A)   | Rim Ø (B) |
| JPW19270 | Fuel   | 38              | 74        |
| JPW19271 | Fuel   | 50              | 87        |
| JPW19272 | Diesel | 38              | 74        |
| JPW19273 | Diesel | 50              | 87        |
| JPW19274 | Water  | 38              | 74        |
| JPW19275 | Water  | 50              | 87        |

### Lockable Fuel Deck Fillers - Stainless Steel

Polished stainless steel fuel deck fillers, with stainless steel retaining chain, 'O' ring seal and FUEL stamped on lid.

- Includes lock and 2x stainless steel keys.

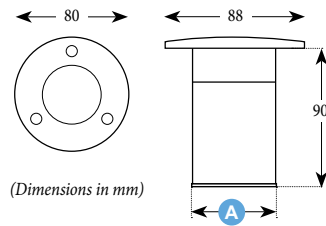

JPW19260  
Straight base



JPW19265  
Stepped base to suit two hose sizes

| Part No. | Suits Hose (A) mm |
|----------|-------------------|
| JPW19260 | 50                |
| JPW19265 | 30 and 50         |

### Keyless Deck Fill 45deg - Stainless Steel

Flush mount cast 316-grade stainless deck fillers with 45deg angled hose connection and a flip-up key to ensure easy removal. Features coarse thread, 'O' ring seal, retaining chain and filler type identification moulded into the lid.

- 4mm countersunk fastening holes.

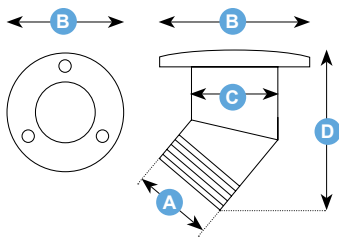

| Part No. | Type   | Dimensions (mm) |    |    |    |
|----------|--------|-----------------|----|----|----|
|          |        | A               | B  | C  | D  |
| JPW19269 | Fuel   | 38              | 74 | 45 | 75 |
| JPW19277 | Fuel   | 50              | 80 | 53 | 90 |
| JPW19278 | Diesel | 38              | 74 | 45 | 75 |
| JPW19279 | Diesel | 50              | 80 | 53 | 90 |
| JPW19280 | Water  | 38              | 74 | 45 | 75 |
| JPW19281 | Water  | 50              | 80 | 53 | 90 |
| JPW19282 | Waste  | 38              | 74 | 45 | 75 |
| JPW19283 | Waste  | 50              | 80 | 53 | 90 |

### Lockable Fuel Deck Filler 45deg - Stainless Steel

Same style as above with 45° angled hose connection.

- Includes lock and 2x stainless steel keys.

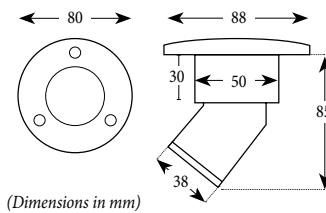

| Part No. | Hose Size (mm) |
|----------|----------------|
| JPW19267 | 38             |



### Replacement Retaining Chain for Deck Fillers

Keeps the deck filler cap secured to the base.

- Total length: 195mm

| Part No. |
|----------|
| JPW19262 |



### Nairn Inspection Ports

Manufactured to high tolerances to provide high strength, durability and water-tightness.

- All models include 'O' ring seals.
- Rims and coloured lids are made from ABS plastic.
- Clear lids are made from polycarbonate plastic, to give both high transparency and impact resistance.
- 5" and 6" ports are available with removable kit bags made from woven nylon.



| Part No. |         | Type              | Cut-Out (mm) | I.D. (mm) | O.D. (mm) | Mounting Holes |
|----------|---------|-------------------|--------------|-----------|-----------|----------------|
| White    | Black   |                   |              |           |           |                |
| JPW6030  | JPW6031 | 4" - Screw-in     | 110          | 100       | 144       | 6 x 4.5mm      |
| JPW6032  | JPW6033 | 5" - Screw-in     | 140          | 125       | 170       | 6 x 4.5mm      |
| JPW6041  | JPW6042 | 5" - With Kit Bag | 140          | 125       | 170       | 6 x 4.5mm      |
| JPW6034  | JPW6035 | 6" - Screw-in     | 166          | 150       | 194       | 8 x 4.5mm      |
| JPW6040  | JPW6043 | 6" - With Kit Bag | 166          | 150       | 194       | 8 x 4.5mm      |
| JPW6036  | -       | 8" - Pry Out      | 210          | 190       | 250       | 6 x 6mm        |



### Nairn Inspection Port Replacement Lids

- Clear lids are made from polycarbonate plastic, to give both high transparency and impact resistance.

| Part No. |         |         | Type          | O.D. (mm) |
|----------|---------|---------|---------------|-----------|
| White    | Black   | Clear   |               |           |
| JPW6060  | JPW6055 | JPW6050 | 4" - Lid Only | 113       |
| JPW6061  | JPW6056 | JPW6051 | 5" - Lid Only | 138       |
| JPW6062  | JPW6057 | JPW6052 | 6" - Lid Only | 160       |
| JPW6063  | -       | -       | 8" - Lid Only | 200       |



### Spare O-Rings

| Part No. | Size       |
|----------|------------|
| JPW6070  | 4" (100mm) |
| JPW6071  | 5" (125mm) |
| JPW6072  | 6" (150mm) |
| JPW6073  | 8" (200mm) |



### Inspection Ports - Full Cover Lid

Made from high density polymer with a textured surface and screw-in threaded lid that covers screw holes.

- Finger grip opening lid with rubber ring to seal with base.
- Six 4.5mm mounting holes.



| Part No. |         | Type           | Cut-Out (mm) | I.D. (mm) | O.D. (mm) |
|----------|---------|----------------|--------------|-----------|-----------|
| White    | Black   |                |              |           |           |
| JPW6045  | JPW6044 | 6" - Screw Out | 163          | 152       | 210       |

### Inspection Port - Smooth Lid

Made from durable UV-resistant ASA white plastic, smooth surface style with screw-in finger grips on lid. Pry-out lid has no finger grip holes.

- Includes 'O' ring seal.
- Six 4.5mm mounting holes



| Part No. | Type           | Cut-Out (mm) | I.D. (mm) | O.D. (mm) |
|----------|----------------|--------------|-----------|-----------|
| JPW6047  | 4" Screw-in    | 120          | 100       | 155       |
| JPW6046  | 6" Pry-out lid | 165          | 155       | 205       |
| JPW6048  | 6" Screw-in    | 165          | 150       | 205       |
| JPW6049  | 8" Screw-in    | 210          | 200       | 250       |

### Inspection Ports

Made from ABS plastic, screw-in threaded lid with flush mounted style.

- Finger grips with rubber ring to seal.
- Six 4.5mm mounting holes.



| Part No. |         | Cut-Out (mm) | I.D. (mm) | O.D. (mm) |
|----------|---------|--------------|-----------|-----------|
| White    | Black   |              |           |           |
| JPW6074  | JPW6075 | 110          | 102       | 145       |
| JPW6076  | JPW6077 | 135          | 128       | 170       |
| JPW6078  | JPW6079 | 160          | 155       | 205       |

### Adjustable Opening Key for Deck Plates

Easily open any size deck plate.

| Part No. |
|----------|
| JPW6059  |



### Deck Plates Finger Grip Opening - Stainless Steel

Heavy duty 316-grade polished stainless steel with a handy finger grip opening mould instead of the standard key system.



| Part No. | Cut-Out (mm) | I.D. (mm) | O.D. (mm) |
|----------|--------------|-----------|-----------|
| JPW19195 | 87           | 83        | 123       |
| JPW19196 | 110          | 102       | 147       |
| JPW19197 | 135          | 127       | 173       |
| JPW19198 | 162          | 150       | 196       |

### Deck Plates - Stainless Steel

Heavy duty 316-grade stainless steel deck plate with mirror polish.

- Rubber 'O' ring seal for a watertight closure.
- Includes opening key.



JPW19101A  
Replacement Key

| Part No.  | Hole Dia        |      | Outside Diameter (mm) | Cut-out Size (mm) |
|-----------|-----------------|------|-----------------------|-------------------|
|           | (in)            | (mm) |                       |                   |
| JPW19100  | 4               | 100  | 140                   | 110               |
| JPW19102  | 5               | 127  | 176                   | 136               |
| JPW19103  | 6               | 152  | 198                   | 162               |
| JPW19101A | Replacement Key |      |                       |                   |

### Bomar Waterproof Aluminium Deck Plate



This commercial-grade, heavy-duty aluminium inspection port is 100% waterproof. A flush ring pull latch enables complete removal of the lid.

- Corrosion-resistant aluminium with a non-skid checker plate surface.
- Thick watertight rubber seal.
- Six 5mm mounting holes.



| Part No.  | Cut-Out (mm) | I.D. (mm) | O.D. (mm) | Height (mm) |
|-----------|--------------|-----------|-----------|-------------|
| JPW171675 | 276          | 223       | 306       | 30          |

### Cast Alloy Tank Filler / Drain Bung with Slotted Cap

Base is cast aluminium that can be welded or screwed to surface.

- Includes rubber 'O' ring seal and white acetal slot cap.

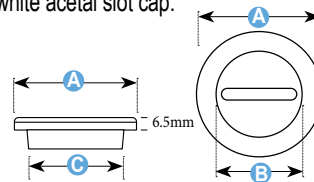

| Part No. | Dimensions (mm) |    |    |
|----------|-----------------|----|----|
|          | A               | B  | C  |
| JPW5212  | 93              | 55 | 75 |



### Aluminium Weld-On Deck Plates with Acetal Lid

Heavy duty marine-grade aluminium weld-on base and 20mm thick acetal lid with key holes for opening.

- Rubber 'O' ring seal ensures a watertight seal.



White Lid

Black Lid

| Part No.  |           | Dimensions (mm) |          |     |
|-----------|-----------|-----------------|----------|-----|
| White Lid | Black Lid | A               | B        | C   |
| JPW5208   | JPW5207   | 145             | (4") 100 | 118 |
| JPW5210   | JPW5209   | 195             | (6") 150 | 165 |
| JPW5206   | JPW5205   | 245             | (8") 200 | 217 |

### Cast Aluminium Drain Bungs

Cast aluminium drain plug designed to be welded or drilled for screw-in installation. Supplied with rubber 'O' ring seals in the cap.

- Replacement caps are available in aluminium or black acetal.



JPW5214

JPW5213

Replacement Plugs

JPW5219

JPW5220

### Opening Keys Suits Weld-on Deck Plates



| Part No. | Distance Between Pins (mm) | Suits Lid Size (mm) |
|----------|----------------------------|---------------------|
| JPW5211  | 120                        | 150 & 200           |

| Part No. | Description                                 | Dimensions (mm) |    |    |
|----------|---|-----------------|----|----|
|          |   | A               | B  | C  |
| JPW5213  | Cast Alloy Bung & Base                      | 72              | 45 | 50 |
| JPW5214  | Cast Alloy Bung with Acetal Plug            | 60              | 45 | 50 |
| JPW5219  | Replacement Aluminium Plug & O-ring 38mm    |                 |    |    |
| JPW5220  | Replacement Black Acetal Plug & O-ring 38mm |                 |    |    |

**Transom Well Drain 55mm**

White nylon fine threaded drain with push-on grip flanged end fitting.

- Can be used for draining motor or anchor wells.
- Simply cut to length required.

| Part No. | Overall Length (mm) | Cut-out (mm) |
|----------|---------------------|--------------|
| JPW5420  | 59                  | 25           |



**Rubber Trim Ring - Oval**

Protect wiring and plumbing from chaffing by neatly finishing holes in bulkheads, engine wells, etc.

- Made from soft black PVC plastic to give excellent weather and chemical resistance.



| Part No. | Colour | Hole Size L x W (mm) | Cut-Out L x W (mm) | O.D. Total L x W (mm) |
|----------|--------|----------------------|--------------------|-----------------------|
| JPW5293  | Black  | 115 x 60             | 120 x 62           | 135 x 82              |

**Oval Hawse Pipe Flange - Stainless Steel**

Oval shape hawse pipe made from cast 316-grade stainless steel.

- Used mainly as a rope guide through the gunwale of larger boats.
- Highly polished finish.



| Part No. | L x W x H (mm) | Cut-Out (mm) | I.D. Hole (mm) |
|----------|----------------|--------------|----------------|
| JPW19000 | 140 x 64 x 25  | 103 x 46     | 93 x 37        |
| JPW19001 | 238 x 135 x 30 | 190 x 88     | 175 x 75       |

**Rubber Slop Stoppers - Round**

Splash proof round slop stopper boot to prevent damage to cables and hoses in engine wells.

- Soft PVC plastic for excellent weather resistance and long term durability.
- 45mm intrusion.



| Part No. | Colour | Hole Dia (mm) | Cut-Out (mm) | Outside Dia (mm) |
|----------|--------|---------------|--------------|------------------|
| JPW5294  | White  | 50            | 62           | 90               |
| JPW5300  | Black  | 50            | 62           | 90               |

**Rectangle Hawse Pipe Flange - Stainless Steel**

Rectangle flange with oval cutout used mainly as a rope guide through the gunwale of larger boats.

- Cast 316-grade stainless steel with highly polished finish.



| Part No. | L x W x H (mm) | I.D. Hole (mm) |
|----------|----------------|----------------|
| JPW19002 | 132 x 63 x 25  | 90 x 37        |

**Rubber Slop Stopper - Oval**

Splash proof oval slop stopper boot that prevents damage to cables and hoses in engine wells, etc.

- Soft black PVC plastic.
- 45mm intrusion



| Part No. | Colour | Hole Size L x W (mm) | Cut-Out L x W (mm) | Overall L x W (mm) |
|----------|--------|----------------------|--------------------|--------------------|
| JPW5301  | Black  | 115 x 60             | 120 x 62           | 135 x 80           |

**Rubber Trim Ring - Round**

Protect wiring and plumbing from chaffing by neatly finishing holes in bulkheads, engine wells, etc.

- Excellent weather and chemical resistance.
- Made from soft PVC plastic.
- 6mm maximum panel thickness.



| Part No. | Colour | Cut-Out (mm) | Outside Dia (mm) |
|----------|--------|--------------|------------------|
| JPW5292  | Black  | 65           | 90               |

**Rubber Bungs - Black**

Tapered rubber bungs suitable for use in dinghies and plugging holes between 11mm and 25mm.

| Part No. | Hole Size (mm) | Type    |
|----------|----------------|---------|
| JPW6939  | 11 - 14        | Size 3  |
| JPW6940  | 16 - 19        | Size 7  |
| JPW6941  | 18 - 21        | Size 8  |
| JPW6942  | 20 - 25        | Size 10 |



**Expansion Bung with Snap Release**

Black 25mm bung drain made from flexible, durable nylon.

- Push into tube and snap for a watertight fit.
- Easy-to-use snap handle for release and removal.



| Part No. | Hole Size |
|----------|-----------|
| JPW5411  | 25mm (1") |

### Bungs with Snap Handle

Expansion bung expands when handle is pushed down.

- Made from nylon.



| Part No. | To Suit Hole Size (mm) |
|----------|------------------------|
| JPW5358  | 25                     |
| JPW5359  | 35                     |
| JPW5360  | 40                     |

### Plastic Bung with 22mm Base Cut-Out

Small size drain bung and base, made from UV-resistant marine-grade nylon with fine thread.

- 19mm internal flow size with unique high flow retainer ring design and neoprene 'O' ring seal.
- Two 4mm countersunk fastening holes.
- 19mm bung plug diameter.



| Part No. |                | Description          |
|----------|----------------|----------------------|
| Single   | Bulk Bag of 10 |                      |
| JPW5372  | JPW5372B       | Bung & Base Assembly |

### Plastic Bung with 25mm Base Cut-Out - Fine Thread

All plastic with plastic washer and retainer lug.

- Fine thread with 19mm internal flow size.
- Two 4mm countersunk fastening holes.
- 19mm bung plug diameter.



JPW5390

JPW5391

| Part No. |                | Description          |
|----------|----------------|----------------------|
| Single   | Bulk Bag of 10 |                      |
| JPW5391  | JPW5391B       | Bung & Base Assembly |
| JPW5390  | JPW5390B       | Bung Plug only       |

### Plastic Bung with 25mm Base Cut-Out - Coarse Thread

Standard size, coarse thread drain bung. All plastic with plastic washer and retainer lug.

- 17mm internal flow size.
- 19mm bung plug diameter.



JPW5370

JPW5380

| Part No. |                | Description          |
|----------|----------------|----------------------|
| Single   | Bulk Bag of 10 |                      |
| JPW5380  | JPW5380B       | Bung & Base Assembly |
| JPW5370  | JPW5370B       | Bung Plug only       |

### Plastic Bungs with 25mm Base Cut-Out

High quality bung and base made from UV-resistant marine-grade nylon.

- 20mm internal flow size with unique high flow retainer ring design and neoprene 'O' ring seal.
- Two 4mm countersunk fastening holes.
- 20mm bung plug diameter.



JPW5393

JPW5395

JPW5392

JPW5394



| Part No. |                | Description                |
|----------|----------------|----------------------------|
| Single   | Bulk Bag of 10 |                            |
| JPW5392  | JPW5392B       | Bung & Base Assembly White |
| JPW5393  | JPW5393B       | Bung Plug only White       |
| JPW5394  | JPW5394B       | Bung & Base Assembly Black |
| JPW5395  | JPW5395B       | Bung Plug only Black       |



**Plastic Bungs with 30mm Base Cut-Out**

UV-resistant marine-grade nylon bung.

- 25mm internal flow size with unique high flow retainer ring design and neoprene 'O' ring seal.
- Two 4mm countersunk fastening holes.
- 25mm bung plug diameter.



| Part No. |                | Description                |
|----------|----------------|----------------------------|
| Single   | Bulk Bag of 10 |                            |
| JPW5396  | JPW5396B       | Bung & Base Assembly White |
| JPW5397  | JPW5397B       | Bung Plug only White       |
| JPW5398  | JPW5398B       | Bung & Base Assembly Black |
| JPW5399  | JPW5399B       | Bung Plug only Black       |

**Plastic Bungs with 40mm Base Cut-Out**

High quality large size drain bung and base manufactured from UV-resistant marine-grade nylon.

- Large 35mm internal flow size with unique high flow retainer ring design and neoprene 'O' ring seal.
- Opening large enough to allow prawn heads, etc. to pass through.
- Four 4mm countersunk fastening holes.
- 35mm bung plug diameter.



| Part No. |               | Description                |
|----------|---------------|----------------------------|
| Single   | Bulk Bag of 5 |                            |
| JPW5365  | JPW5365B      | Bung & Base Assembly White |
| JPW5366  | JPW5366B      | Bung Plug only White       |
| JPW5367  | JPW5367B      | Bung & Base Assembly Black |
| JPW5368  | JPW5368B      | Bung Plug only Black       |

**Plastic Bung with 38mm Base Cut-Out**

UV-resistant black nylon bung and black washer.

- 30mm internal flow size.
- Two 4mm countersunk fastening holes.
- 30mm bung plug diameter.



| Part No. |                | Description          |
|----------|----------------|----------------------|
| Single   | Bulk Bag of 10 |                      |
| JPW5400  | JPW5400B       | Bung & Base Assembly |
| JPW5410  | JPW5410B       | Bung Plug only       |

**Plastic Bungs with 50mm Base Cut-Out**

High quality large size drain bung and base manufactured from UV-resistant marine-grade nylon.

- Large 45mm internal flow size with unique high flow retainer ring design and neoprene 'O' ring seal.
- Opening large enough to allow prawn heads, etc. to pass through.
- Four 4mm countersunk fastening holes.
- 45mm bung plug diameter.



| Part No. |               | Description                |
|----------|---------------|----------------------------|
| Single   | Bulk Bag of 5 |                            |
| JPW5361  | JPW5361B      | Bung & Base Assembly White |
| JPW5362  | JPW5362B      | Bung Plug only White       |
| JPW5363  | JPW5363B      | Bung & Base Assembly Black |
| JPW5364  | JPW5364B      | Bung Plug only Black       |



### Nylon Bung with Stainless Steel Base

Coarse threaded nylon bung plug with polished 316 grade stainless steel base, complete with nitrile seal and retainer lug.

- 25mm internal flow size.
- 19mm plug diameter.
- Two 4mm countersunk fastening holes.



| Part No. | Base L x W (mm) |
|----------|-----------------|
| JPW5354  | 51 x 37         |

### Drain Bung and Base - Stainless Steel

316 grade stainless steel nut type plug complete with nitrile rubber seal and retainer lug.

- 25mm internal flow size.
- 19mm plug diameter.
- Two 5mm countersunk fastening holes.



| Part No. | Base L x W (mm) |
|----------|-----------------|
| JPW5356  | 50 x 37         |

### Weld-On Polished Aluminium Drain Bung with Plastic Bung

Round drain plug with aluminium housing designed for weld in use, complete with nitrile rubber seal and retainer lug.

- 31mm internal flow size.
- 47mm cut-out.



| Part No. | Base Dia (mm) |
|----------|---------------|
| JPW5375  | 62            |

### Drain Plug Polished Stainless Steel

Polished 316 grade stainless steel 3 piece drain plug, complete with nitrile rubber seal and secure thread for a watertight seal.

- 30mm internal flow size.
- 30mm cut-out.



| Part No. | Overall Dia (mm) | Plug Dia (mm) |
|----------|------------------|---------------|
| JPW5353  | 50               | 20            |

### Brass Garboard Drain Plug and Housing

50mm diameter brass housing complete with 3/4" brass drain plug.



JPW5226  
Replacement Plug



JPW5225

| Part No. | Description                                |
|----------|--|
| JPW5225  | Brass Garboard Drain Plug And Housing 50mm |
| JPW5226  | Replacement Brass Garboard Drain Plug      |



**Shock Cord Buttons**

Plastic cord button to suit 5-7mm bungee straps.

- High quality and UV-stabilised.

| Part No. | Colour |
|----------|--------|
| JPW5443  | White  |
| JPW5444  | Black  |



**Shock Cord Utility Loops**

Shockcord loops for tensioning canopies and covers as well as securing ice box lids, etc. UV-stabilised moulded nylon head fitting with shock cord loop.

| Part No. |         | Loop Size (mm) | Cord Dia (mm) |
|----------|---------|----------------|---------------|
| Black    | White   |                |               |
| JPW5500  | JPW5505 | 70             | 5             |
| JPW5501  | JPW5506 | 80             | 5             |
| JPW5502  | JPW5507 | 90             | 5             |
| JPW5503  | -       | 100            | 5             |
| JPW5504  | -       | 110            | 5             |
| JPW5509  | -       | 160            | 5             |



Length of loop taken from fixing point to extent of loop.

**Lashing Hooks - Nylon**

Strong, high quality and UV-stabilised.



| Part No. |         | Type       | Suits Cord Dia (mm) | Base Size (mm) |
|----------|---------|------------|---------------------|----------------|
| White    | Black   |            |                     |                |
| JPW5456  | JPW5457 | Horizontal | 8                   | 42 x 22        |
| JPW5458  | JPW5459 | Vertical   | 5                   | 42 x 19        |

**Lashing Buttons - Nylon**

Strong, high quality and UV-stabilised.

| Part No. | Colour | Dimensions L x W (mm) |
|----------|--------|-----------------------|
| JPW5460  | White  | 33 x 25               |
| JPW5461  | Black  | 33 x 25               |



**Flat Webbing Saddles - Black Nylon**

Strong, high quality and UV-stabilised.



| Part No. | Fastening Holes | Webbing Size (mm) |
|----------|-----------------|-------------------|
| JPW5485  | 2 x 4mm         | 25                |
| JPW5487  | 2 x 5mm         | 25                |
| JPW5489  | 2 x 5mm         | 50                |

**Nylon Saddle**

Strong and high quality.

- Two 5mm fastening holes.

| Part No. | Description | Dimensions L x W (mm) |
|----------|-------------|-----------------------|
| JPW5483  | Black Nylon | 50 x 17               |



**Nylon Conduit Saddle**

Strong and high quality.

- Two 5mm fastening holes.

| Part No. | Hole Diameter |
|----------|---------------|
| JPW5491  | 30            |



**Webbing Strap Buckle - Nylon**

| Part No. | Description                     |
|----------|---------------------------------|
| JPW5463  | 25mm Nylon Webbing Strap Buckle |



**25mm Webbing Hook - Stainless Steel**

- 316 stainless steel canopy strap hook.
- Suits 25mm webbing.

| Part No. | Dimensions W x H (mm) |
|----------|-----------------------|
| JPW5462  | 35 x 33               |



**25mm Webbing Snap Hook - Stainless Steel**

- 316-grade stainless steel, suits 25mm webbing.
- Sold as a pair.

| Part No. | Dimensions W x H (mm) |
|----------|-----------------------|
| JPW4920  | 35 x 54               |



**Shock Cords Olive - Red**

Strong, high quality and UV-stabilised.



| Part No. | Cord Size (mm) | Dimensions |     |
|----------|----------------|------------|-----|
|          |                | A          | B   |
| JPW5464  | 4 - 5          | 46         | 5   |
| JPW5465  | 5 - 7          | 67         | 6.5 |

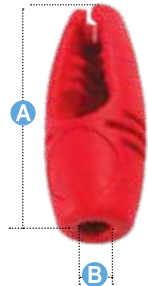

**Shock Cords Quick Connect - Black**

- Strong, high quality and UV-stabilised.



| Part No. | Dimensions (mm) |       |    |
|----------|-----------------|-------|----|
|          | A               | B     | C  |
| JPW5480  | 45              | 3 - 5 | 7  |
| JPW5481  | 58              | 4 - 6 | 9  |
| JPW5482  | 70              | 5 - 8 | 11 |



### Stayput Fasteners - Stainless Steel

Made from 316-grade stainless steel, offering increased strength and a smooth appearance. Use to fix fabric to a boat, building or vehicle.

- Secure using a 6g countersunk screw or a 3mm pop rivet.
- Sold individually.



| Part No. | Type       |
|----------|------------|
| JPW5421  | Horizontal |
| JPW5422  | Vertical   |

### Canopy Deck Mounts - Nylon

Nylon plastic with nut and bolt to suit tube end.



| Part No. | Size   | Dimensions L x W x H (mm) | Gap Size (mm) | Colour |
|----------|--------|---------------------------|---------------|--------|
| JPW5432  | Small  | 60 x 19 x 20              | 7             | White  |
| JPW5438  | Medium | 60 x 18 x 30              | 7             | Black  |

### Stayput Plastic Fasteners - Single

Horizontal or vertical fasteners fix fabric to a boat, building or vehicle. Accepts one single eyelet (9.5mm approx).

- Secure using a 6g countersunk screw or a 3mm pop rivet.
- Supplied as a blister pack of two.



| Part No. | Type       | Colour |
|----------|------------|--------|
| 916520   | Horizontal | White  |
| 916521   | Horizontal | Black  |
| 916524   | Vertical   | White  |
| 916525   | Vertical   | Black  |

### Canopy Thumb Screws - Nylon

High quality, UV-stabilised moulded nylon plastic tops. Used with canopy mounts, making it easier to tighten or loosen your canopy.

- Stainless bolts with 1/4" UNC thread.



| Part No. | Type      | Bolt Length (mm) | Colour |
|----------|-----------|------------------|--------|
| JPW5427  | Star Bolt | 15               | White  |
| JPW5428  | Star Bolt | 15               | Black  |
| JPW5429  | 2 Eared   | 25               | White  |
| JPW5433  | 3 Eared   | 25               | White  |
| JPW5445  | 3 Eared   | 25               | Black  |

### Stayput Plastic Fasteners - Double

Horizontal or vertical fasteners fix fabric to a boat, building or vehicle. Accepts two (double) eyelets (9.5mm approx).

- Secure using a 6g countersunk screw or a 3mm pop rivet.
- Supplied as a blister pack of two.



| Part No. | Type       | Colour |
|----------|------------|--------|
| 916522   | Horizontal | White  |
| 916526   | Vertical   | White  |

### Canopy Tube Knuckles - Nylon

- UV-stabilised nylon.



| Part No. |         | Suits Tube O.D (mm) |
|----------|---------|---------------------|
| White    | Black   |                     |
| JPW5430  | JPW5437 | 20                  |
| JPW5455  | JPW5435 | 25                  |

### Tube Holders - Black Nylon

High quality and UV-stabilised. Ideal for paddles, boat hooks, landing nets etc.

- Size shown is the outside diameter of the tube that it will hold.
- Sold as singles or in pairs.
- 2 pre-drilled fastening holes.



| Part No. |          | Suits Tube Dia (mm) |
|----------|----------|---------------------|
| Single   | Pair     |                     |
| JPW5474  | JPW5474P | 16                  |
| JPW5475  | JPW5475P | 20                  |
| JPW5476  | JPW5476P | 25                  |
| JPW5477  | JPW5477P | 30                  |
| JPW5478  | JPW5478P | 38                  |
| JPW5479  | JPW5479P | 48                  |

### Canopy Tube Ends - Nylon

- UV-stabilised nylon.



| Part No. |         | Suits Tube I.D (mm) | Suits Tube O.D (mm) | Tongue Size (mm) |
|----------|---------|---------------------|---------------------|------------------|
| White    | Black   |                     |                     |                  |
| JPW5431  | JPW5436 | 16                  | 20                  | 6.5              |
| JPW5452  | JPW5453 | 19                  | 25                  | 8                |
| JPW5454  | JPW5434 | 21                  | 25                  | 7                |

### Economy Range Canopy Fittings - Black Nylon

Nylon canopy fittings to suit each other.



| Part No. | Type                    |
|----------|-------------------------|
| JPW5440  | 16mm Tube Insert        |
| JPW5441  | 16 - 18mm Tube Knuckle  |
| JPW5442  | Deck Mount with Screw   |
| JPW5446  | Thumb Screw Replacement |



### Canopy Tube Knuckles - Stainless Steel

Mirror polished cast 316-grade stainless steel, ideal for setting up tube-work around your boat.

- Secure tube with allen key grub screw.

| Part No. | Suits Tube O.D. | Type       |
|----------|-----------------|------------|
| JPW19074 | (7/8") 22mm     | Heavy Duty |
| JPW19077 | (1") 25mm       | Heavy Duty |
| JPW19076 | (3/4") 19mm     | Standard   |
| JPW19106 | (7/8") 22mm     | Standard   |
| JPW19107 | (1") 25mm       | Standard   |



### Hinged Canopy Tube Knuckle Clamps - Stainless Steel

Made from 316-grade stainless steel, the design allows quick and easy fitting to a canopy system without having to disassemble the entire canopy.

| Part No. | Suits Tube O.D. |
|----------|-----------------|
| JPW19162 | (7/8") 22mm     |
| JPW19163 | (1") 25mm       |



### Canopy Tube Ends - Stainless Steel

Cast 316-grade stainless steel, mirror polished.

| Part No. | Suits Tube O.D. (mm) | Suits Tube I.D. (mm) | Tongue Size (mm) |
|----------|----------------------|----------------------|------------------|
| JPW19075 | 20                   | 16                   | 7                |
| JPW19160 | 22                   | 19                   | 5.5              |
| JPW19161 | 25                   | 22                   | 5.5              |
| JPW19159 | 31                   | 28                   | 9                |



### Canopy Deck Hinges - Stainless Steel

Cast 316-grade stainless steel mirror polished deck mount hinges.

- Connect canopy to deck or rail.



| Part No. | Base Size (mm)                             | Height (mm) | Gap (mm) | Pin Type | Mount Type |
|----------|--|-------------|----------|----------|------------|
| JPW19086 | 60 x 19                                    | 37          | 9.3      | Screw    | Deck 90°   |
| JPW19088 | 52 x 26                                    | 29          | 9.8      | Screw    | Deck 90°   |
| JPW19108 | 60 x 16                                    | 34          | 7.7      | Release  | Deck 90°   |
| JPW19109 | 61 x 22                                    | 37          | 7.7      | Screw    | Rail       |
| JPW19110 | 61 x 22                                    | 37          | 7.7      | Release  | Rail       |
| JPW19111 | 56 x 20                                    | 34          | 7.7      | Screw    | Deck 10°   |
| JPW19121 | 56 x 20                                    | 34          | 7.7      | Release  | Deck 10°   |
| JPW19120 | Replacement Canopy Mount Quick Release Pin |             |          |          |            |

### Canopy Tube Ends - Stainless Steel

Mirror polished cast 316-grade stainless steel.

- Small grub screw for securing to tube.

| Part No. | Suits Tube O.D. (mm) | Tongue Size (mm) | Type       |
|----------|----------------------|------------------|------------|
| JPW19119 | 20                   | 7                | Standard   |
| JPW19104 | 22                   | 7                | Standard   |
| JPW19105 | 25                   | 7                | Standard   |
| JPW19072 | 22                   | 10               | Heavy Duty |
| JPW19073 | 25                   | 8                | Heavy Duty |



Standard



Heavy Duty

### Canopy Side Mounts - Stainless Steel

Cast 316-grade stainless steel side deck mount connect canopy to vertical or near vertical surfaces.



| Part No. | Base Size (mm) | Height (mm) | Type       |
|----------|----------------|-------------|------------|
| JPW19087 | 50 x 22        | 28          | Standard   |
| JPW19089 | 72 x 47        | 32          | Heavy Duty |

### Round Base Rail Fittings - Stainless Steel

Cast 316-grade stainless steel rail fittings with round base, mirror polished finished.



30° Angle



45° Angle



60° Angle



90° Angle

| Part No. | Suits Tube O.D. | Angle Degree |
|----------|-----------------|--------------|
| JPW19130 | 7/8" (22mm)     | 30°          |
| JPW19131 | 1" (25mm)       | 30°          |
| JPW19132 | 7/8" (22mm)     | 45°          |
| JPW19133 | 1" (25mm)       | 45°          |
| JPW19128 | 7/8" (22mm)     | 60°          |
| JPW19129 | 1" (25mm)       | 60°          |
| JPW19140 | 3/4" (19mm)     | 90°          |
| JPW19134 | 7/8" (22mm)     | 90°          |
| JPW19135 | 1" (25mm)       | 90°          |

### 60 Degree Rail Centre and End Fittings

Make your own hand rails to any desired length using these end and centre fittings

- Made from cast 316-grade stainless steel.
- 60° angle.
- Two 4mm fastening holes.



End cap

Centre

| Part No. |          | Suits Tube O.D. |
|----------|----------|-----------------|
| End      | Centre   |                 |
| JPW19054 | JPW19053 | 7/8" (22mm)     |
| JPW19125 | JPW19123 | 1" (25mm)       |

### Tee Fittings - Stainless Steel

Cast 316-grade stainless steel tee fittings, mirror polished finished.



90° Angle



60° Angle

| Part No. | Suits Tube O.D. | Angle Degree | Grub Screws |
|----------|-----------------|--------------|-------------|
| JPW19141 | 3/4" (19mm)     | 90°          | One side    |
| JPW19138 | 7/8" (22mm)     | 90°          | One side    |
| JPW19139 | 1" (25mm)       | 90°          | One side    |
| JPW19136 | 7/8" (22mm)     | 60°          | Centre      |
| JPW19137 | 1" (25mm)       | 60°          | Centre      |

### Corner Fittings 3 x Tube - Stainless Steel

Cast 316-grade stainless steel fittings, mirror polished finished.

- 3 tubes at 90° angle.



| Part No. | Suit Tubes O.D. |
|----------|-----------------|
| JPW19149 | 7/8" (22mm)     |
| JPW19150 | 1" (25mm)       |

### Cross Fittings 4 x Tube - Stainless Steel

Cast 316-grade stainless steel four tube cross fittings, mirror polished finished.



| Part No. | Suits Tube O.D. |
|----------|-----------------|
| JPW19142 | 7/8" (22mm)     |
| JPW19143 | 1" (25mm)       |

### End Mount Rail Fittings - Stainless Steel

Cast 316-grade stainless steel hand rail ends with 90° centres and curved finish.

- To suit 22mm and 25mm outside diameter tubes.



| Part No. | Suits Tube O.D. | Height (mm) |
|----------|-----------------|-------------|
| JPW19145 | 7/8" (22mm)     | 38          |
| JPW19146 | 1" (25mm)       | 38          |

### 90 Degree Elbow Rail End Fittings - Stainless Steel

Cast 316-grade stainless steel hand rail ends with 90 degree elbow.



| Part No. | Suits Tube O.D. |
|----------|-----------------|
| JPW19147 | 7/8" (22mm)     |
| JPW19148 | 1" (25mm)       |

**Flush Mount Flag Pole Holder - Stainless Steel**

Cast 316 grade stainless steel flag pole holder with 30 degree angled oval head and white plastic removable cap.

- Suits 25mm pole.
- Sits inside the deck/gunwale for a flush finish.
- Three 5mm fastening holes.



| Part No. | Head Size L x W (mm) | Cut-out Size (mm) |
|----------|----------------------|-------------------|
| JPW19069 | 72 x 50              | 33                |

**Surface Mount Flag Pole Holder - Stainless Steel**

Cast 316-grade stainless steel angled style with allen key grub screw to hold flag pole in place.

- Three 4mm fastening holes.



| Part No. | Dia of Pole (mm) | Base Dia. (mm) | Height (mm) |
|----------|------------------|----------------|-------------|
| JPW19067 | 25               | 68             | 48          |

**Deck Mount Antenna Base - Stainless Steel**

Straight antenna base with three 6mm fastening holes.

- Suits various internally threaded GPS antennas and other aerials.



| Part No. | Base Dia (mm) | Height (mm) | Thread |
|----------|---------------|-------------|--------|
| JPW1286  | 71            | 105         | 3/4"   |

**Deck Mount Antenna Base - White Nylon**

ABS plastic standard straight antenna base with three 6mm fastening holes.

- Suits various internally threaded GPS antennas and other aerials.



| Part No. | Base Dia (mm) | Height (mm) | Thread |
|----------|---------------|-------------|--------|
| JPW1285  | 70            | 40          | 3/4"   |

**Swivel Mount Antenna Base - White Nylon**

ABS plastic quick release antenna base adjusts in all directions and suits various internally threaded GPS antennas and other aerials.

- Four 8mm fastening holes.
- Stainless steel bolts and nuts.



| Part No. | Base Dimensions L x W (mm) | Thread |
|----------|----------------------------|--------|
| JPW1284  | 93 x 65                    | 3/4"   |

**Rail Mount Antenna Holder - Stainless Steel**

Heavy duty cast stainless steel rail mount antenna base to suit 7/8" or 1" rails.

- Full ratchet angle adjustment and locking handle.
- Suits various internally threaded GPS antennas and other aerials.



| Part No.  | Suits Tube Size | Thread |
|-----------|-----------------|--------|
| JPW19066B | 7/8"-1"         | 3/4"   |

**Swivel Mount Antenna Base - Stainless Steel**

Heavy duty cast 316-grade stainless steel deck mount antenna base. Suits various internally threaded GPS antennas and other aerials.

- Base mount horizontally or vertically with double angle adjustment and locking handle.
- Four 6mm fastening holes.



| Part No.  | Dimensions L x W x H (mm) | Thread |
|-----------|---------------------------|--------|
| JPW19066A | 92 x 64 x 108             | 3/4"   |

### Boat Rego Numbers and Letters

- Self adhesive white square sticker with black text.
- Meets Department of Transport approval.
- Must be purchased in multiples of 10.
- Small: 65 x 50mm
- Large: 160 x 85mm



| Small Part No. | Large Part No. | Number / Letter |
|----------------|----------------|-----------------|
| JPW5351-0      | JPW5350-0      | 0               |
| JPW5351-1      | JPW5350-1      | 1               |
| JPW5351-2      | JPW5350-2      | 2               |
| JPW5351-3      | JPW5350-3      | 3               |
| JPW5351-4      | JPW5350-4      | 4               |
| JPW5351-5      | JPW5350-5      | 5               |
| JPW5351-6      | JPW5350-6      | 6               |
| JPW5351-7      | JPW5350-7      | 7               |
| JPW5351-8      | JPW5350-8      | 8               |
| JPW5351-9      | JPW5350-9      | 9               |
| JPW5351-A      | JPW5350-A      | A               |
| JPW5351-B      | JPW5350-B      | B               |
| JPW5351-C      | JPW5350-C      | C               |
| JPW5351-D      | JPW5350-D      | D               |
| JPW5351-E      | JPW5350-E      | E               |
| JPW5351-F      | JPW5350-F      | F               |
| JPW5351-G      | JPW5350-G      | G               |
| JPW5351-H      | JPW5350-H      | H               |
| JPW5351-I      | JPW5350-I      | I               |
| JPW5351-J      | JPW5350-J      | J               |
| JPW5351-K      | JPW5350-K      | K               |
| JPW5351-L      | JPW5350-L      | L               |
| JPW5351-M      | JPW5350-M      | M               |
| JPW5351-N      | JPW5350-N      | N               |
| JPW5351-O      | JPW5350-O      | O               |
| JPW5351-P      | JPW5350-P      | P               |
| JPW5351-Q      | JPW5350-Q      | Q               |
| JPW5351-R      | JPW5350-R      | R               |
| JPW5351-S      | JPW5350-S      | S               |
| JPW5351-T      | JPW5350-T      | T               |
| JPW5351-U      | JPW5350-U      | U               |
| JPW5351-V      | JPW5350-V      | V               |
| JPW5351-W      | JPW5350-W      | W               |
| JPW5351-X      | JPW5350-X      | X               |
| JPW5351-Y      | JPW5350-Y      | Y               |
| JPW5351-Z      | JPW5350-Z      | Z               |

### Multipurpose Board Rack Stainless Steel Rail Mount Support Arms

Convenient and space-saving storage solution, perfect for kayaks, surfboard or paddle boards.

- Made from 304-grade stainless steel.
- Heavy duty rail mount brackets suits 20-25mm rails.
- Simple setup with no additional fixings required.
- Sold as a pair.



| Part No. | Dimensions L x W (mm) | Tube Dia (mm) |
|----------|-----------------------|---------------|
| JPW6168  | 640 x 400             | 25            |

### Stainless Steel Davit - Pair

Polished 316-grade stainless steel lightweight davit with recessed deck mounts. Sold as a pair with lifting tackle included.

- Removable arms to provide more space on deck and transom.
- Ideal for lifting outboard motors, sea bags, scuba gear etc.
- Can be used on sailboats or powerboats.
- Weatherproof and corrosion resistant.
- Removable arms swivel around 360°
- Lifting capacity per pair: 100kg or 160kg.
- Overall L x H: 800 x 1050mm.



#### Kit includes:

- 2 x Davit Arms (Height: 1050mm) with removable bases and under deck base plates
- 2 x 8mm snap hooks
- 2 x 6mm 'D' shackles
- 2 x 40mm pulleys
- 2 x 8mm nylon ropes (Length: 2.5m)

\*Mounting bolts not supplied.

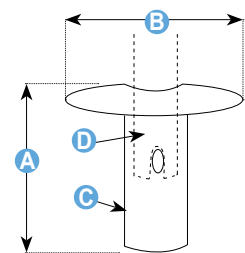

Removable Base

| Part No. | Capacity (kg) | Base Dimensions (mm) |     |    |    |
|----------|---------------|----------------------|-----|----|----|
|          |               | A                    | B   | C  | D  |
| JPW6174  | 100           | 120                  | 130 | 45 | 40 |
| JPW6175  | 160           | 130                  | 145 | 54 | 50 |

### Above Platform Telescopic Ladders - Stainless Steel

316-grade stainless steel above platform telescopic boarding ladders. Compact design includes hinged brackets to allow ladder to retract, flip back and fold over platform when not required.

- 4 different styles available with either 2-steps, 3-steps or 4-steps.
- Secure closed with the bungee cord supplied.

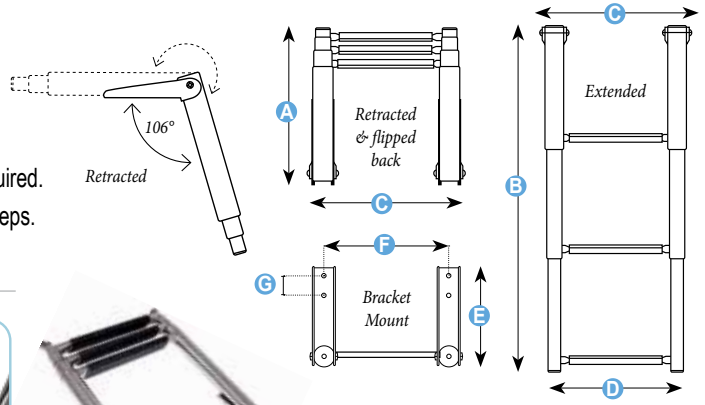

### Telescopic Ladder - Moulded Ribbed Steps

Moulded ribbed nylon tread on each step for comfortable boarding.

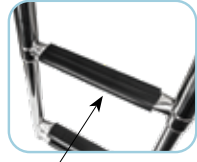

JPW6149 Replacement Nylon Tread



JPW6142 Retracted & flipped back



JPW6144 Retracted

JPW6143 Extended

| Part No. | Type   | Dimensions (mm) See diagram above |      |     |     |     |     |    |
|----------|--------|-----------------------------------|------|-----|-----|-----|-----|----|
|          |        | A                                 | B    | C   | D   | E   | F   | G  |
| JPW6143  | 2-Step | 350                               | 600  | 285 | 270 | 150 | 252 | 38 |
| JPW6142  | 3-Step | 380                               | 880  | 295 | 270 | 150 | 255 | 38 |
| JPW6144  | 4-Step | 405                               | 1160 | 305 | 270 | 165 | 255 | 38 |

### Telescopic Ladders - Double Tube Steps

Steps made from double stainless steel tubes with moulded black nylon for a more stable tread.



JPW6152 Retracted & flipped back

JPW6152 Extended



JPW6152 Retracted

| Part No. | Type   | Dimensions (mm) See diagram above |      |     |     |     |     |    |
|----------|--------|-----------------------------------|------|-----|-----|-----|-----|----|
|          |        | A                                 | B    | C   | D   | E   | F   | G  |
| JPW6152  | 3-Step | 370                               | 875  | 345 | 320 | 180 | 300 | 38 |
| JPW6153  | 4-Step | 395                               | 1145 | 350 | 220 | 205 | 300 | 63 |

### Telescopic Ladders - Extra Wide Steps

Extra wide moulded solid nylon steps for sure footing.



JPW6155 Retracted & flipped back

JPW6154 Extended

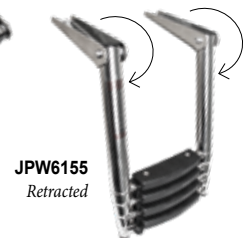

JPW6155 Retracted

| Part No. | Type   | Dimensions (mm) See diagram above |      |     |     |     |     |    |
|----------|--------|-----------------------------------|------|-----|-----|-----|-----|----|
|          |        | A                                 | B    | C   | D   | E   | F   | G  |
| JPW6154  | 3-Step | 370                               | 875  | 300 | 275 | 180 | 255 | 38 |
| JPW6155  | 4-Step | 395                               | 1145 | 300 | 275 | 205 | 255 | 63 |

### Telescopic Ladders - Top Rail

Moulded ribbed nylon tread and top rail with finger grips to make it easier to get into and out of the water.



JPW6149 Replacement Nylon Tread

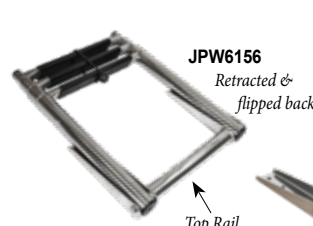

JPW6156 Retracted & flipped back

JPW6156 Extended



JPW6156 Retracted

| Part No. | Type   | Dimensions (mm) See diagram above |     |     |     |     |     |    |
|----------|--------|-----------------------------------|-----|-----|-----|-----|-----|----|
|          |        | A                                 | B   | C   | D   | E   | F   | G  |
| JPW6156  | 3-Step | 370                               | 875 | 295 | 275 | 180 | 255 | 38 |

### Above Platform Telescopic Dive Ladders - Stainless Steel

Heavy duty 316-grade stainless steel above platform telescopic boarding ladder is ideal for diving, with wide open steps giving easy access for divers wearing fins.

- Retracts and flips back over platform when not in use.
- Dual centre post for added strength and assist when climbing.

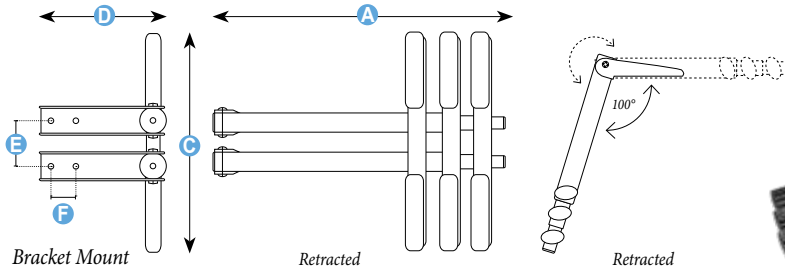

| Part No. | Type   | Dimensions (mm) |      |     |     |    |    |
|----------|--------|-----------------|------|-----|-----|----|----|
|          |        | A               | B    | C   | D   | E  | F  |
| JPW6150  | 3-Step | 430             | 860  | 335 | 180 | 59 | 33 |
| JPW6151  | 4-Step | 480             | 1125 | 335 | 210 | 71 | 33 |

### Above Platform Telescopic Ladder with Hand Rails - Stainless Steel

316-grade stainless steel telescopic boarding ladder with large top hand rails to make it easier to get into and out of the water.

Hinged brackets allow the steps to be retracted and flipped back, for easy storage when not in use.

- Supplied flat - some assembly is required.
- Secure closed with the bungee cord supplied.

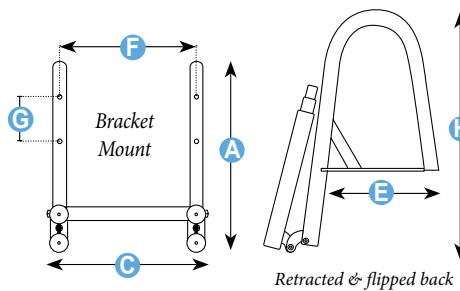

| Part No. | Type   | Dimensions (mm) |      |     |     |     |     |    |     |
|----------|--------|-----------------|------|-----|-----|-----|-----|----|-----|
|          |        | A               | B    | C   | D   | E   | F   | G  | H   |
| JPW6163  | 4-Step | 390             | 1431 | 390 | 368 | 270 | 330 | 90 | 554 |

### Above Platform Telescopic Ladder with Grab Handles - Stainless Steel

Constructed from 316-grade stainless steel this 4-step ladder has two folding grab handles, a top hand rail and heavy duty steps with double tubes for strength and a nylon insert for grip.

- Grab handles and telescopic rungs stow away compactly when not in use.
- Secure closed with the bungee cord supplied.

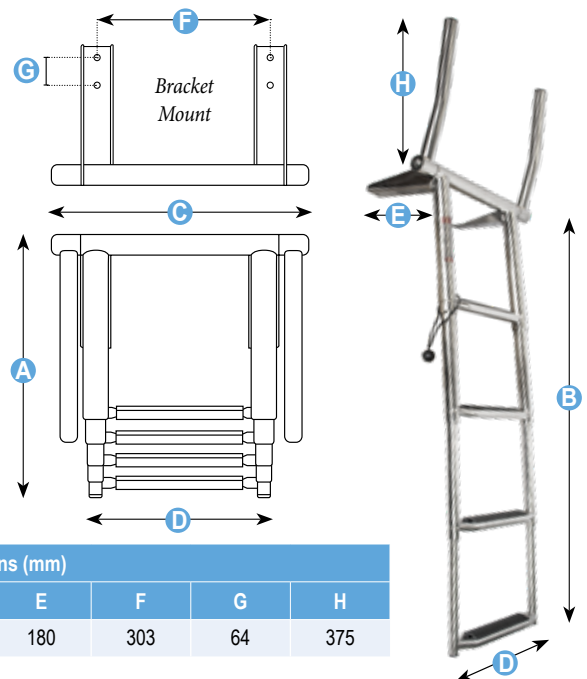

| Part No. | Type   | Dimensions (mm) |      |     |     |     |     |    |     |
|----------|--------|-----------------|------|-----|-----|-----|-----|----|-----|
|          |        | A               | B    | C   | D   | E   | F   | G  | H   |
| JPW6164  | 4-Step | 470             | 1140 | 460 | 320 | 180 | 303 | 64 | 375 |

### Under Platform Telescopic Ladders with Locking Bracket - Stainless Steel

316-grade stainless steel telescopic boarding ladders for under platform mounting. Steps retract into the mounting bracket and have a movable locking bracket to secure into place when not in use.

- Anti-slip and UV-stabilised moulded ribbed steps.

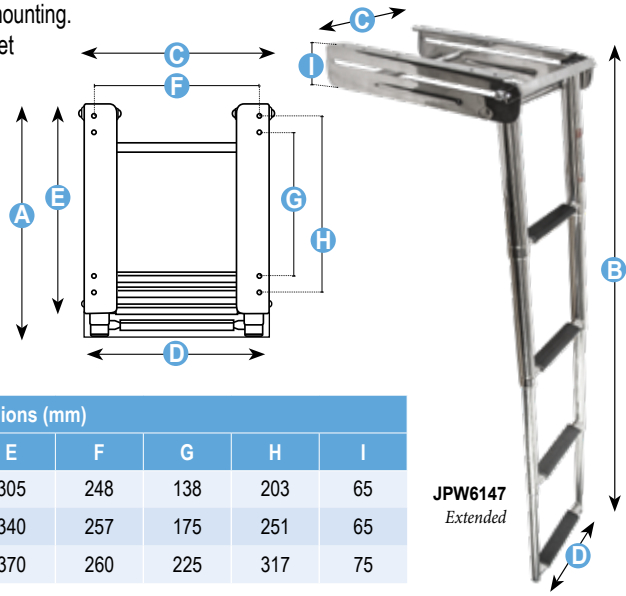
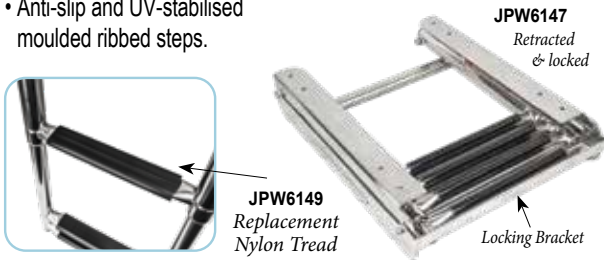

| Part No. | Type   | Dimensions (mm) |      |     |     |     |     |     |     |    |
|----------|--------|-----------------|------|-----|-----|-----|-----|-----|-----|----|
|          |        | A               | B    | C   | D   | E   | F   | G   | H   | I  |
| JPW6145  | 2-Step | 360             | 600  | 290 | 270 | 305 | 248 | 138 | 203 | 65 |
| JPW6146  | 3-Step | 380             | 880  | 300 | 270 | 340 | 257 | 175 | 251 | 65 |
| JPW6147  | 4-Step | 400             | 1160 | 300 | 270 | 370 | 260 | 225 | 317 | 75 |

### Under Platform Self Locking Telescopic Ladder - Stainless Steel

316-grade stainless steel telescopic boarding ladders for under platform mounting. Steps retract into the mounting bracket and self-lock securely into place for stowing.

- Anti-slip and UV-stabilised wide ribbed rounded tube steps.

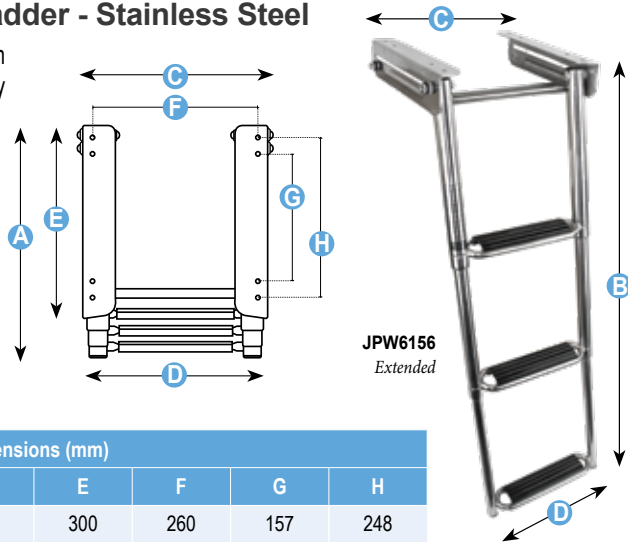
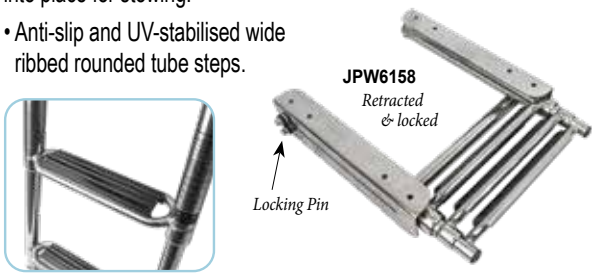

| Part No. | Type   | Dimensions (mm) |     |     |     |     |     |     |     |
|----------|--------|-----------------|-----|-----|-----|-----|-----|-----|-----|
|          |        | A               | B   | C   | D   | E   | F   | G   | H   |
| JPW6158  | 3-Step | 380             | 875 | 300 | 275 | 300 | 260 | 157 | 248 |

### Under Platform Telescopic Ladder with Grab Handles - Stainless Steel

Constructed from 316-grade stainless steel this under platform ladder has two folding grab handles, a top hand rail and heavy duty steps with double tubes for strength and a nylon insert for grip.

- Grab handles and telescopic rungs stow away into bracket.
- Locks into place when not in use.
- Anti-slip and UV-stabilised moulded ribbed steps.

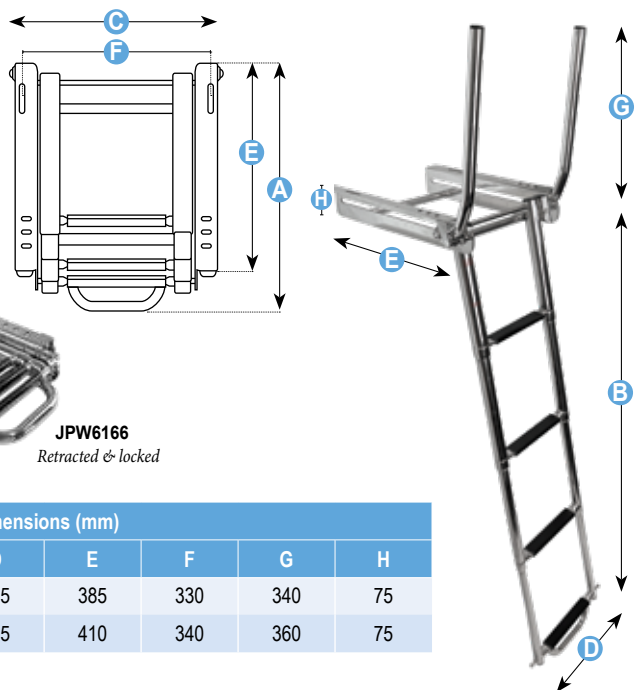

| Part No. | Type   | Dimensions (mm) |      |     |     |     |     |     |    |
|----------|--------|-----------------|------|-----|-----|-----|-----|-----|----|
|          |        | A               | B    | C   | D   | E   | F   | G   | H  |
| JPW6165  | 3-Step | 470             | 875  | 370 | 275 | 385 | 330 | 340 | 75 |
| JPW6166  | 4-Step | 500             | 1145 | 375 | 275 | 410 | 340 | 360 | 75 |

### Inflatable Boat Telescopic Ladders - Stainless Steel

316-grade stainless steel telescopic ladder designed to fit over inflatable boat tubes and secure with two tie down straps supplied. Top rail grab handle makes it easier to get into and out of the water. Complete with a velcro fastening strap, the ladder retracts and folds away compactly when not in use.

- Anti-slip and UV-stabilised moulded ribbed steps.

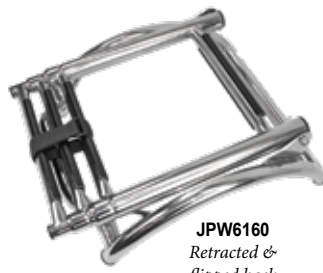
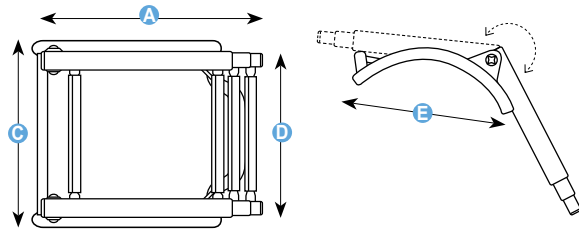

JPW6160  
Retracted & flipped back

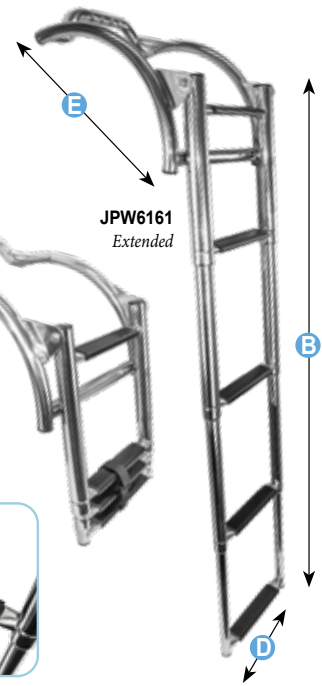

JPW6161  
Extended



Tie down straps



JPW6160  
Retracted

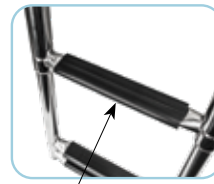

JPW6149  
Replacement Nylon Tread

| Part No. | Type   | Dimensions (mm) |      |     |     |     |
|----------|--------|-----------------|------|-----|-----|-----|
|          |        | A               | B    | C   | D   | E   |
| JPW6160  | 4-Step | 435             | 870  | 340 | 275 | 380 |
| JPW6161  | 5-Step | 465             | 1190 | 345 | 270 | 380 |

### Consealed Box Ladder Telescopic with Grab Handles - Stainless Steel

Designed for convenience, this heavy duty 316-grade stainless steel telescopic ladder mounts neatly into the boarding platform and is completely hidden within its flush-mounted box.

- Ideal for transom or under-deck installations.
- Spring-loaded lid with flush latch catch.
- Top grab handles.
- Anti-slip and UV-stabilised wide ribbed rounded tube steps.

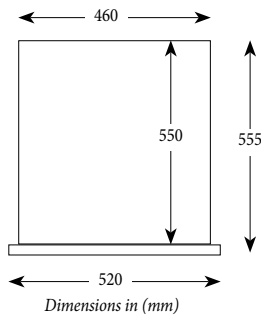

| Part No. | Type   |
|----------|--------|
| JPW6167  | 4-Step |



### Folding Step - Stainless Steel

A heavy duty, solid cast 316-grade stainless steel folding step.

- Two 8mm fastening holes.



| Part No. | Body L x W (mm) | Step L x W (mm) |
|----------|-----------------|-----------------|
| JPW19170 | 108 x 44        | 83 x 50         |



**Transducer Covers - Stainless Steel**



Eliminate the spray and splash-back from your boat's transducer, and reduce any water noise that might affect the picture on your sounder.



JPW12847



JPW12848

| Part No. | Type  | Size (mm) |
|----------|-------|-----------|
| JPW12847 | Small | 150 x 135 |
| JPW12848 | Large | 160 x 200 |

**Transducer Brackets - Aluminium**

Anodised aluminium sliding transducer brackets with adjustable position.

- Removable for easy stowage or security reasons.
- Bracket length : 205mm
- JPW4933: Includes 25mm hole.

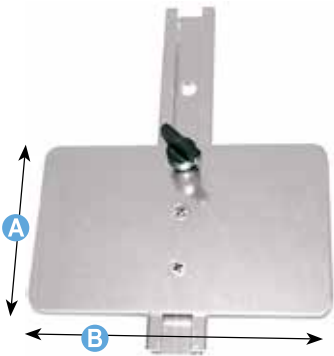

JPW4932



JPW4933

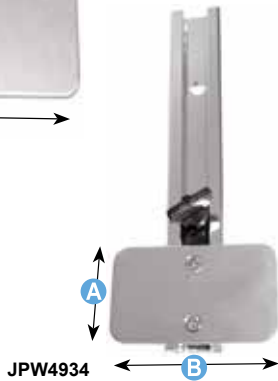

JPW4934

| Part No. | Plate Type   | Dimensions (mm) |     |    |
|----------|--------------|-----------------|-----|----|
|          |              | A               | B   | C  |
| JPW4932  | Large Flat   | 93              | 152 | -  |
| JPW4933  | Right Angled | 112             | 90  | 65 |
| JPW4934  | Small Flat   | 50              | 85  | -  |



# SCANSTRUT

A selection of Scanstrut products are stocked and available to order online. Additional items from the full range are available on request. Contact our sales team for more information.

## Scanstrut Radar Mounts

Diverse mounting options for radar and accessory installations, designed to meet various marine vessel requirements.



### Aluminium PowerTower

Available in 2 heights, black or white options with a wide range of accessories.



### Stainless Steel PowerTower

Created using a highly polished 316-grade stainless steel.



### Composite PowerTower

Aesthetic single piece moulding with no joints, made from composite materials.



### Starlink PowerTower

Designed to fit Starlink® Flat High-Performance.



### Self-Levelling Radar

Self-levelling mount range ensures the radar stays level with the horizon at all times.



### Mast

A cost-effective and space-saving solution for installing directly onto masts.



### Modular Dual PowerTower

Specifically designed for mounting the most up to date radars with Satcom, camera or nav lights.



### Tapered Mast

Designed for mounting lights, cameras, GPS/VHF antenna in one premium installation.



### Starlink Tapered Mast

Mount radar, thermal camera, aerials, and Starlink® Flat High-Performance in one installation.



### PowerTower Central Mounts

Designed for mounting antennas and lights to PowerTowers.



### PowerTower Plates

Required for mounting accessories to PowerTowers



### PowerTower Wedge

Angles the radar ensuring that it is elevated to an optimal position.



### StopGull Air Seagull Deterrent

The StopGull Air prevents the landing of seagulls and coastal birds on boats, boat's hardtops, inflatables, sailboats and professional vessels. The flags housed at the end of the bar start to rotate when wind hits them, deterring birds from perching on the boat.

- Easy to install, arms fold upwards and can removed from the base for stowing.
- Can be applied to any part of your boat using additional supports (sold separately).



Overall length includes flags

| Part No. | Length (m) |
|----------|------------|
| JPW10310 | 1.85       |
| JPW10311 | 2.35       |

### StopGull Air Handrail Support

This StopGull Air Support can be attached to 22 - 38mm diameter handrails and is made of anodised aluminium.

- Install in a vertical or horizontal position.
- Quick and easy to install.



| Part No. | Height (mm) | Length (mm) | Width (mm) |
|----------|-------------|-------------|------------|
| JPW10315 | 130         | 70          | 16         |

### StopGull Air Boom and Folded Bimini Support

This StopGull support allows you to install the StopGull Air device at any kind of bimini when they are folded or aluminium booms when the sails are lowered.

- Includes long textile straps with safety fasteners.



| Part No. | Straps Length (m) |
|----------|-------------------|
| JPW10319 | 1                 |

### StopGull Air Large Rail Mount Support 38mm To 110mm

The StopGull Air Large Rail Support mount can be attached to rails from 38mm - 110mm diameter. Simply place the support on top of the rail, and pull the elastic cord tight around the rail, securing with the eyelets.



| Part No. | Height (mm) | Length (mm) | Width (mm) |
|----------|-------------|-------------|------------|
| JPW10328 | 40          | 160         | 240        |

### StopGull Air Open Bimini Support

For mounting the StopGull Air onto an open bimini and is adaptable for tubes from 22 to 38mm. Made from 316-grade stainless steel.

- Can be folded with the bimini arch support installed.



| Part No. | Height (mm) | Length (mm) | Width (mm) |
|----------|-------------|-------------|------------|
| JPW10316 | 60          | 60          | 40         |

### StopGull Air Suction Cup Support

The Suction Cup Support is suitable for installation of the StopGull Air device at hatches, outboard motors, etc. Includes the base to fit the StopGull Air easily.

| Part No. | Height (mm) | Length (mm) | Width (mm) |
|----------|-------------|-------------|------------|
| JPW10317 | 100         | 70          | 70         |



### StopGull Air RIB Support Kit

This StopGull Support will fit the StopGull Air device to all kinds of inflatable boats. Made from a nautical acrylic fabric with flexible ropes and four hooks to fix at the external profile of the inflatable boat. It also includes a telescopic mast for its final tightening.



| Part No. |
|----------|
| JPW10320 |

### StopGull Air Keeper

Designed to be installed on the radar, TV antenna, lamp posts, marine installations, etc. where gulls and shorebirds use as a lookout point.

- Deters birds by the disposal of its rods and their movement by the wind.
- Installation requires an industrial adhesive.



| Part No. | Diameter (mm) | Height (mm) |
|----------|---------------|-------------|
| JPW10326 | 500           | 310         |

### StopGull Air Boat Vent 3 Support

The StopGull Air can be installed on the mooring canvas through the Boat Vent 3 device to provide two great benefits. It prevents seagulls and coastal birds from landing on the mooring canvas and at the same time allows the inside of the boat to aerate to prevent moisture, mildew and bad smell.



| Part No. | Diameter (mm) | Height (mm) |
|----------|---------------|-------------|
| JPW10322 | 120           | 50          |

### StopGull Air S27 Transparent

The swivel piece StopGull S27 is designed for installing on critical points on your boat to deter gulls and shorebirds. Prevents birds landing on the mast spreaders, top of mast, nav lights, etc.

- Includes a double sided adhesive for installation.
- Can be installed at port signals.

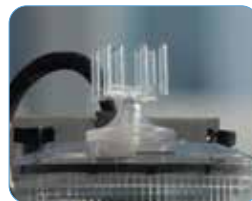

| Part No. | Diameter (mm) | Height (mm) |
|----------|---------------|-------------|
| JPW10327 | 50            | 55          |

### StopGull Air Boat Vent Telescopic Support Pole



| Part No. | Length (mm) |
|----------|-------------|
| JPW10324 | 850 - 1500  |
| JPW10325 | 950 - 1800  |

### StopGull Air Sandbag Support

The StopGull Sandbag Support is suitable for installing the StopGull Air device on rough surfaces as well as deck mats.

- Sand not included.



| Part No. | Size (mm) |
|----------|-----------|
| JPW10321 | 350 x 350 |

### StopGull Air Base Mounts

Replacement base or spare deck mount to securely attach the StopGull Air, to be easily relocated to various positions without the need to purchase multiple complete units.

| Part No. | Type   |
|----------|--|
| JPW10340 | Replacement Base with Pin                          |
| JPW10341 | Spare Deck Mount for Additional Mounting Positions |



**JPW10340**  
Replacement Base  
will clip onto Deck Mount



**JPW10341**  
Deck Mount

# HOW TO ORDER

Select products from the catalogue or through our website using the product categories or search function. Make note of the part numbers to facilitate ordering.

## ONLINE



Login to our website  
with your customer username & password.

[www.jpwmarine.com.au](http://www.jpwmarine.com.au)

If you know our product codes, use the  
'Quick Order' form for a speedy checkout.

## PHONE



Call us during standard  
Western Australian business hours on

**(08) 6253 3000**

to place order by phone.

## EMAIL

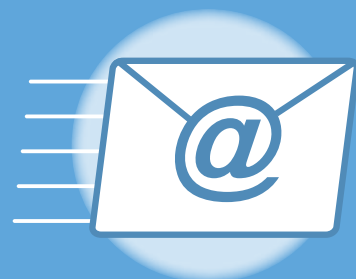

Email your order to

[orders@jpwmarine.com.au](mailto:orders@jpwmarine.com.au)



# JPW MARINE

WHOLESALE MARINE SPECIALISTS