

ELECTRICAL 15

SWITCHES & PANELS

Rocker Switches	15.02 - 15.06
Switch Panels	15.05 - 15.08
Push Buttons & Toggle Switches ...	15.07 - 15.09
Ignition Switches	15.09
Circuit Breakers	15.10 - 15.12
Battery Switches	15.12 - 15.13
Power, USB & Accessory Sockets .	15.13 - 15.16

BATTERIES & ACCESSORIES

Solar Panels	15.17
Wireless Phone Chargers	15.18
Battery Chargers	15.18 - 15.20
Jumpstarter & Power Bank	15.20
Battery Boxes & Trays	15.20 - 15.21
Battery Terminals.....	15.21

CONNECTORS & ACCESSORIES

Solenoids	15.11
Anderson Connectors	15.16
Cable Outlets & Connectors	15.16 - 15.17
Fuses & Fuse Holders	15.22 - 15.24
Terminal Blocks	15.24
Junction Boxes	15.25
Deutsch Connectors	15.25
Terminals and Connectors	15.26 - 15.28
Cable Lugs	15.28
Cable Tools & Heat Gun.....	15.29
Cable Clamps, Clips & Ties.....	15.29 - 15.30
Tapes.....	15.30
Heatshrink & Sleeve Tubing.....	15.30 - 15.31
Cables	15.31 - 15.32

TANK SENDERS & GAUGES

Tank Level Senders	15.33 - 15.34
Tank Level Adaptors.....	15.34
Waste Tank Level Senders	15.34
Gauges.....	15.33 - 15.35

BLOWERS, HORNS & COOLING SYSTEMS

In-Line Bilge Blowers	15.36
Evaporative Cooling System	15.37
Fridge & Freezers	15.37
Electric Horns.....	15.37



Carling V-Series Contura II Rocker Switches

These waterproof rocker switches are the switch of choice for the marine industry. Feature snap-in panel mounting, an interchangeable actuator and quick-connect terminals with barriers.

- White switches and other configurations not listed below are available on request.
- See switch circuit diagram below.



IP68



Black Bracket
No LED Indication



Black Bracket
1x LED Indication



Black Bracket
2x LED Indication



White Bracket
1x LED Indication

Part No.	Carling Code	Switch Configuration	Current Rating	Voltage	LED Indication	Switch Circuit	Pole
Black Bracket							
JPW12607	V4DAS00BAZC	On/On	20A	12V	None	4	SP
JPW12616	VDDAS00BAZC	On/On	20A	12V	None	4	DP
JPW12606	V4DAD66BANC	On/On	20A	12V	2	4	SP
JPW12619	V1BAS00BAZC	On/Off	15A	24V	None	1	SP
JPW12604	V1DAS00BAZC	On/Off	20A	12V	None	1	SP
JPW12615	VADAS00BAZC	On/Off	20A	12V	None	1	DP
JPW12601	V1BAB80BAMC	On/Off	15A	24V	1	1	SP
JPW12602	V1DAB60BAMC	On/Off	20A	12V	1	1	SP
JPW12623	VABAB80BAMC	On/Off	15A	24V	1	1	DP
JPW12614	VADAB60BAMC	On/Off	20A	12V	1	1	DP
JPW12605	V2DAS00BAZC	(On)/Off	20A	12V	None	2	SP
JPW12620	V6BAS00BAZC	On/Off/On	15A	24V	None	6	SP
JPW12610	V6DAS00BAZC	On/Off/On	20A	12V	None	6	SP
JPW12617	VJDAS00BAZC	On/Off/On	20A	12V	None	6	DP
JPW12608	V6BAD88BANC	On/Off/On	15A	24V	2	6	SP
JPW12622	VJBAD88BANC	On/Off/On	15A	24V	2	6	DP
JPW12609	V6DAD66BANC	On/Off/On	20A	12V	2	6	SP
JPW12621	V7BAS00BAZC	On/Off/(On)	15A	24V	None	7	SP
JPW12612	V7DAS00BAZC	On/Off/(On)	20A	12V	None	7	SP
JPW12611	V7DAB60BAMC	On/Off/(On)	20A	12V	1	7	SP
JPW12624	VLBAS00BAZC	(On)/Off/(On)	15A	24V	None	8	DP
JPW12613	V8DAS00BAZC	(On)/Off/(On)	20A	12V	None	8	SP
JPW12618	VLDAS00BAZC	(On)/Off/(On)	20A	12V	None	8	DP
White Bracket							
JPW12603	V1DAB60WAMY	On/Off	20A	12V	1	1	SP
JPW12599	V1BAB80WAMY	On/Off	15A	24V	1	1	SP
JPW12598	V6DAD66WANY	On/Off/On	20A	12V	2	6	SP
JPW12597	V7DAB60WAMY	On/Off/(On)	20A	12V	1	7	SP
JPW12596	V8DAS00WAZY	(On)/Off/(On)	20 A	12V	None	8	SP

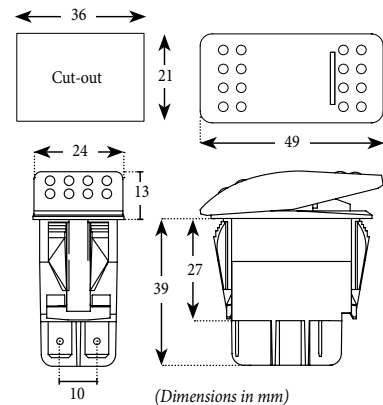

*Position shown inside brackets are momentary action only (not latching)

*SP = Single Pole / *DP = Double Pole

Carling V-Series Contura II Rocker Switch - Circuit Diagram

Symbol	Designates
○	Terminals and Contacts
◯	Lamp Location
—○—	Maintained Circuits
— —	Other Position
—○—	Momentary Circuits

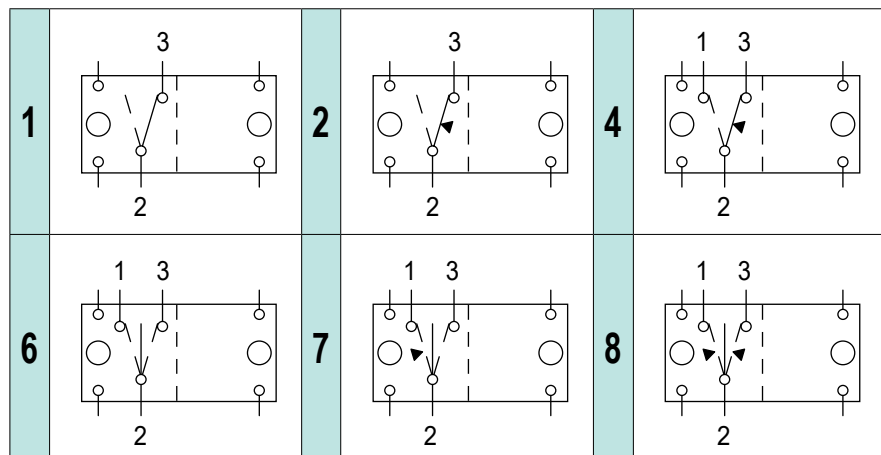

LED Illuminated Sealed Rocker Switches - No Actuator Cover

Water resistant switches specially designed for marine or outdoor applications. Dual voltage equipped with durable and power efficient LED lamps with blue or red LED illumination.

- Amp rating 20A @ 12V / 10A @ 24V.



Part No.	LED	Switch Config.	Pole
JPW12520	Blue	On/Off	SP
JPW12521	Red	On/Off	SP
JPW12522	Blue	(On)/Off	SP
JPW12523	Red	(On)/Off	SP
JPW12524	Blue	On/Off/On	DP
JPW12525	Red	On/Off/On	DP
JPW12526	Blue	(On)/Off/(On)	DP
JPW12527	Red	(On)/Off/(On)	DP



Blue LED



Red LED

*Position shown inside brackets are momentary action only (not latching)
*SP = Single Pole / *DP = Double Pole

LED Illuminated Sealed Rocker Switches - With Actuator Cover

Water resistant LED illuminated sealed rocker switch with laser etched actuator cover.

- Blue or Red LED illumination.
- Laser etched text and logo.
- Various switch functions.
- Amp rating 20A @ 12V / 10A @ 24V.



Part No.		Function	Switch Config.
Blue LED	Red LED		
JPW12530	JPW12531	Anchor Light	On/Off
JPW12532	JPW12533	Underwater Light	On/Off
JPW12534	JPW12535	Flood Light	On/Off
JPW12536	JPW12537	Spot Light	On/Off
JPW12538	JPW12539	Nav/Anc Light	On/Off
JPW12540	JPW12541	Cabin Light	On/Off
JPW12542	JPW12543	Nav Light	On/Off
JPW12544	JPW12545	Deck Light	On/Off
JPW12546	JPW12547	Stereo	On/Off
JPW12548	JPW12549	Wash Down	On/Off
JPW12550	JPW12551	Bilge Pump	On/Off
JPW12552	JPW12553	Bilge Blower	On/Off
JPW12554	JPW12555	Fan	On/Off
JPW12556	JPW12557	Horn	(On)/Off
JPW12558	JPW12559	Livewell	On/Off
JPW12560	JPW12561	Wiper	On/Off
JPW12562	JPW12563	Radio	On/Off
JPW12564	JPW12565	Shower	On/Off
JPW12566	JPW12567	Fresh Water Pump	On/Off
JPW12568	JPW12569	Depth Sounder	On/Off
JPW12570	JPW12571	Trim Tab Port	(On)/Off/(On)
JPW12572	JPW12573	Trim Tab Stbd	(On)/Off/(On)
JPW12574	JPW12575	Anchor Winch	(On)/Off/(On)
JPW12576	JPW12577	Accessory	On/Off

*Position shown inside brackets are momentary action only (not latching)

Rocker Switch Actuator Covers

Actuator covers to suit illuminated LED rocker switches, with laser etched text and logo to suit a wide range of applications.

- Each sold separately.
- Size (H x W): 49 x 26mm

Viper LED Anchor Rocker Switch



LED illuminated marine rocker switch with anchor symbol and "Viper" label. Designed for flush mount and supplied with required fixing hardware.

- Voltage: 12V
- Amps: 20A
- Also available mounted within a stainless steel or aluminium faceplate (see page 15.06).



Part No.	LED	Switch Config.	*Position shown inside brackets are momentary action only (not latching)
JPW12590	Red	(On)/Off/(On)	

Narva Sealed LED Rocker Switches



These top-end switches feature backlit opal panels with red or blue LED illumination to suit both 12 and 24 volt applications.

- Soft rubberised, non-slip texture.
- RV and marine application sticker sets sold separately.
- Amp rating 20A @ 12V / 10A @ 24V.



Inactive

Blue LED

Red LED



N63178BL
50x Marine & RV Sticker Set



Illuminated panel with symbol sticker

Part No.	LED Colour	Switch Config.	Pole
N63158BL	Red	Off/On	SP
N63159BL	Blue	Off/On	SP
N63164BL	Red	Off/(On)	SP
N63165BL	Blue	Off/(On)	SP
N63166BL	Red	On/On	DP
N63167BL	Blue	On/On	DP
N63168BL	Red	On/Off/On	DP
N63169BL	Blue	On/Off/On	DP
N63170BL	Red	Off/On/On	DP
N63171BL	Blue	Off/On/On	DP
N63172BL	Red	(On)/Off/(On)	DP
N63173BL	Blue	(On)/Off/(On)	DP
N63178BL	Marine and RV Sticker Set		

*Position shown inside brackets are momentary action only (not latching)
*SP = Single Pole / *DP = Double Pole

Panel Blanking Plate Cover

Blank switch panel plug for filling empty spots on your rocker switch mounting panel.



Part No.
JPW12649

Rocker Switch Actuator Removal Tool

Used to easily remove and replace actuator covers on rocker switches.



Part No.
JPW12648

Modular Mounting Panels

Individual interconnecting panels for mounting all our rocker switches, allowing switches to be banked together in any combination.

- End or middle sections available in white or black.



JPW12650

JPW12651

JPW12652

JPW12653

Part No.	Section	Colour
JPW12650	End	Black
JPW12651	End	White
JPW12652	Middle	Black
JPW12653	Middle	White

Mounting Panels

Panels perfect for the installation of single, 3 or 6 gang rocker switches.



JPW12656

JPW12657

Part No.	Gang	Colour
JPW12654	1	Black
JPW12655	1	White
JPW12656	3	Black
JPW12657	6	Black



JPW12655

JPW12654

Rocker Switch Aluminium Horizontal Mounting Panels

Mounting panels with black ripple finish, designed for use with all our rocker switches.

- 2mm thick aluminium panels
- 4mm countersunk holes.
- Includes mounting screws.

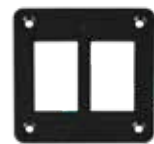

JPW12641



JPW12642



JPW12643

Part No.	Gang	Size (mm)
JPW12641	2	70 x 70
JPW12642	3	96 x 70
JPW12643	4	124 x 70
JPW12644	5	151 x 70
JPW12645	6	179 x 70
JPW12646	8	234 x 70

Narva LED Switch Panels with Fuse Protection



Off/On switches with red 'On' illumination.

- Removable panel cover.
- Includes 46 piece symbol set for RV and marine applications.
- Fuse concealed under face cover.
- Amp Rating: 20A @ 12V / 10A @ 24V.
- Pre-wired for easy installation.



N63190



N63193



N63196

Part No.	No. of Switches	Dimensions (mm)	Cut-Out (mm)
N63190	4	130 x 120	105 x 93
N63193	6	183 x 120	157 x 93
N63196	8	235 x 120	209 x 93



Pre-wired for easy installation

Narva LED Switch Panels with Circuit Breaker Protection



Off/On switches includes 1x Momentary (On) switch.

- 60 piece symbol set for RV and marine application included.
- Circuit breaker concealed under face cover.
- Amp rating 20A @ 12V / 10A @ 24V.
- Pre-wired for easy installation.
- Removable panel cover.

N63191

Symbols, text and switches illuminate green when switched 'On'

Symbols and text glow red when 'Off'



60 piece symbol set



N63194

Easily serviced with a removable cover



Pre-wired for easy installation

Part No.	No. of Switches	Dimensions (mm)	Cut-Out (mm)
N63191	4	130 x 100	108 x 83
N63194	6	183 x 100	160 x 83

Water Resistant Switch Panels with Fuse

Moulded weatherproof "Wave" black panel with fuses. Pre-wired for use (12V) with in-line fuse holders containing a spare fuse for each switch.

- 15Amp waterproof in-line fuses and holders.
- Align to create a large bank of switches.
- Mounting gasket for tight seal.
- Rubber water resistant boots on switches.
- 20Amp rated toggle switches.



JPW12965



JPW12957



JPW12968



JPW12967



Includes 28 assorted panel labels
JPW12947: Spare set

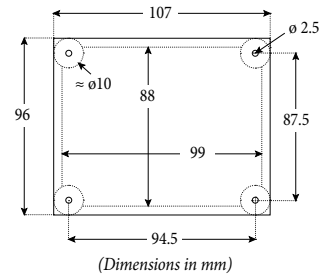

Part No.	No. of Switches	LED Indicators	Accessory
JPW12955	3	Yes	Cig Socket
JPW12965	3	Yes	Dual USB
JPW12957	5	No	Cig Socket
JPW12967	5	Yes	Cig Socket
JPW12968	6	Yes	None
JPW12947	Spare Sticker Set - 28 Assorted Panel Labels		

Water Resistant Switch Panel with Circuit Breaker

Sealed waterproof "Wave" switch panel with LED illuminated lights and manual reset circuit breakers. Ideal for marine applications or caravan and includes panel labels.

- Mounting gasket for watertight seal.
- Rubber water resistant boots on switches.
- 15Amp manual reset circuit breakers.
- Fully wired for use (12V).



Includes 28 assorted panel labels
JPW12947: Spare set

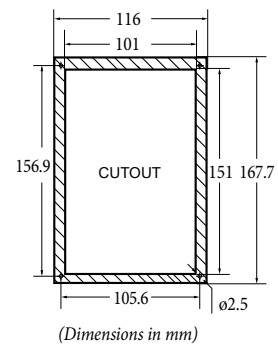

Part No.	No. of Switches	LED indicators
JPW12969	6	Yes
JPW12947	Spare Sticker Set - 28 Assorted Panel Labels	

Curved Water-Resistant Switch Panels with Circuit Breakers

Water resistant curved switch panels with illuminated contura syle rocker switches and manual reset circuit breakers. Includes watertight mounting gasket and hardware.

- Voltage: Multivolt 12/24V
- Current draw: 20A @ 12V / 10A @ 24V



Includes 30 assorted panel labels



JPW12974



JPW12975

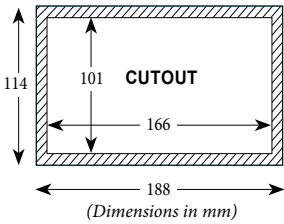

Part No.	No. of Switches	LED Indicators	Accessory
JPW12974	6	Yes	None
JPW12975	5	Yes	Dual USB Charger
JPW12946	Spare Sticker Set - 30 Assorted Panel Labels		

LED Rocker Switch Panels - 12V

WAVE series water resistant On/Off rocker switches with LED indicators, pre-wired for easy installation.

- Reinforced corner prevents cracking from screw holes.
- Added gasket for watertight seal.
- 20A auto reset circuit breaker to ensure safety.



JPW12971



Includes 30 assorted panel labels



JPW12972

Part No.	No. of Switches	Dimensions (mm)	Cut-Out (mm)
JPW12971	4	128 x 100	110 x 92
JPW12972	6	184 x 100	166 x 92

Aluminium Water-Resistant Switch Panels with Circuit Breakers

Water resistant aluminium switch panels with illuminated contura syle rocker switches and manual reset circuit breakers. Includes 30 assorted labels, ideal for marine applications, and a watertight mounting gasket.

- Voltage: Multivolt 12/24V
- Current draw: 20A @ 12V / 10A @ 24V

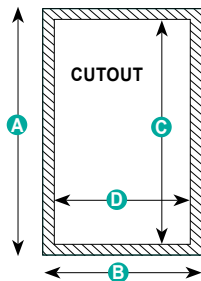

JPW12977



JPW12978



JPW12979

Part No.	No. of Switches	Accessory	Dimensions (mm)			
			A	B	C	D
JPW12977	6	None	191	114	166	96
JPW12978	5	USB Chargers	191	114	166	96
JPW12979	7	USB Chargers	238	114	217	96
JPW12946	Spare Sticker Set - 30 Assorted Panel Labels					

Touch Screen Slimline Control Switch Panels

Backlit LED (white/blue) capacitive touch screen switch panel with almost no mounting depth required. Basic wiring and double sided adhesive for simple DIY installation.

- Not waterproof - install in a dry environment.
- Touch screen technology with silicone rubber buttons.
- Clean flush finish panel surface.
- Built in Resettable Fuse (PPTC).



Backlit blue LED buttons

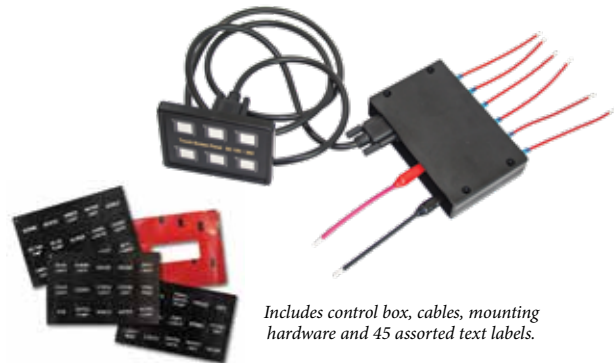

Includes control box, cables, mounting hardware and 45 assorted text labels.

Part No.	Gang	Input	Output	Rating
JPW12962	6	12/24V	12V @ 10A / 24V @ 10A	40A Max

Narva Marine Waterproof Switch Panel

ON/OFF switch panel, vertical or horizontal mount, with replaceable clip-on contour wave covers (Blue & Grey).

- Voltage: 12/24V.
- Current draw: 10A max (per circuit)
15A max (two circuit)



Includes LED back lit labels.



Part No.	Cut-Out (mm)
N63198BL	86 x 40

Stainless Steel Switch Panels with Blue LED On/Off Switches

Sleek switch panels featuring pre-wired removable blue LED On/Off actuation push button switches. The faceplate is made from 316-grade stainless steel and are highly polished to a mirror finish.

- Vertical or horizontal mount.
- Pre-wired ready to fit.
- Includes 4 mounting screws.
- Voltage: 12-24V.
- Amps: 15A.

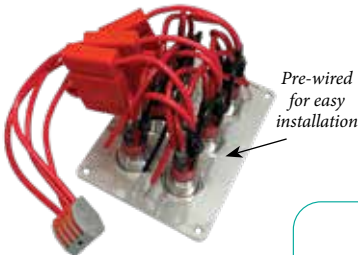

Pre-wired for easy installation



JPW12927
6 Gang with labels



Includes 100x icon labels



Swap switches with other Push Button Switches for customised panels



JPW12926
4 Gang

JPW12927
6 Gang

JPW12928
8 Gang

Part No.	Gang	Overall Size (mm)	Cutout (mm)
JPW12926	4	80 x 80	60 x 60
JPW12927	6	110 x 80	90 x 60
JPW12928	8	140 x 80	120 x 60
JPW12805	Spare Label Sticker Set		

Water Resistant Switch Panels with Blue LED On/Off Switches

ABS plastic switch panels feature pre-wired removable blue LED On/Off actuation push button switches.

- Supplied with o-ring seal and stainless steel face plate.
- Vertical or horizontal mount.
- Pre-wired ready to fit.
- Voltage: 12-24V.
- Amps: 15A.



JPW12915
4 Gang



JPW12917
6 Gang

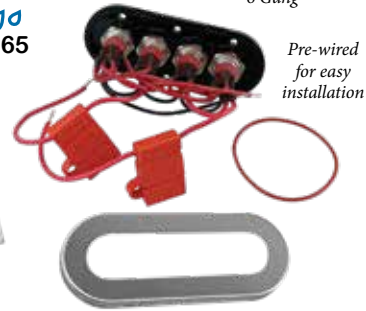

Pre-wired for easy installation



Includes 100x icon labels

Part No.	Gang	Overall Size (mm)	Cutout (mm)
JPW12915	4	130 x 52	107 x 27
JPW12917	6	182 x 52	157 x 27
JPW12805	Spare Label Sticker Set		

Water Resistant Push Button Switches

Pre-wired panel mount LED switch with stainless steel housing and button, with silicon O-ring. Available with solid LED or ring LED in blue or red.

- Standard ON/OFF actuation or Momentary (ON)/OFF.
- Pre-wired ready to fit.
- Voltage: 12-24V.
- Amps: 15A.



Blue Solid LED or Ring LED

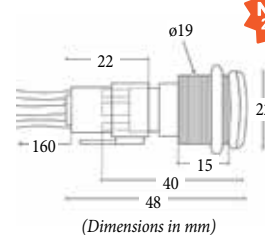

(Dimensions in mm)



Red Solid LED or Ring LED

*Position shown in brackets is momentary action only (not latching)

Part No.	Button Type	Actuation	LED Colour
JPW12766	Solid	ON/OFF	Blue
JPW12767	Solid	ON/OFF	Red
JPW12768	Solid	(ON)/OFF	Blue
JPW12769	Solid	(ON)/OFF	Red
JPW12798	Ring	ON/OFF	Blue
JPW12800	Ring	ON/OFF	Red
JPW12799	Ring	(ON)/OFF	Blue
JPW12801	Ring	(ON)/OFF	Red
JPW12805	Spare Label Sticker Set		

Viper LED Anchor Rocker Switch with Face Plate

Red LED illuminated up/down switch mounted into a polished 316-grade stainless steel or aluminium faceplate.

- (On) momentary / Off / (On) momentary actuation
- Supplied with required fixing hardware.
- Voltage: 12V.
- Amps: 20A.
- Overall size (W x H): 60 x 80mm.



Part No.	Type
JPW12592-1	Stainless Steel
JPW12592-2	Aluminium

Viper Pro Switch Panel with Circuit Breaker & Anchor Rocker Switch

Combination LED illuminated up/down switch and circuit breaker, mounted into a polished 316-grade stainless steel faceplate.

- Includes fixing hardware.
- Voltage: 12V
- Amps: 20A (Rocker)
100A (CB)
- Overall size (W x H): 100 x 80mm.



Part No.
JPW12591

Viper Pro Flush Mount Switch Panel Face Plates

Hand polished to a mirror finish, these face plates are to suit the Viper Pro Rocker Switch or Rocker Switch / Circuit breaker combo.

- Designed for flush mount.
- Includes all necessary fixing hardware.



Single Rocker Switch

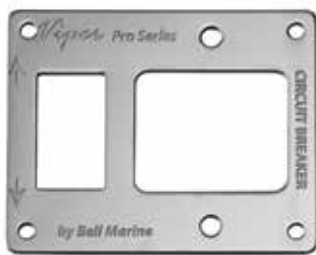

Combo Rocker Switch & Circuit Breaker

Part No.	Suits	Type	W x H (mm)
JPW12595-1	Rocker Switch	Stainless Steel	60 x 80
JPW12595-2	Combo	Stainless Steel	100 x 80
JPW12595-3	Rocker Switch	Aluminium	60 x 80
JPW12595-4	Combo	Aluminium	100 x 80

NARVA On/Off Toggle Switch

Solid brass body with chrome-plated toggle switch

- Single pole, single throw (SPST).
- Screw terminals.

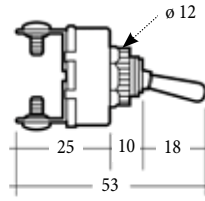

(Dimensions in mm)



Part No.	Configuration	Amp Rating
N60062BL	On/Off	20A @ 12V / 10A @ 24V

NARVA Sealed Metal On/Off Toggle Switch

Single pole, single throw (SPST) toggle switch pre-wired with 200mm leads.

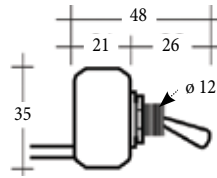

(Dimensions in mm)



Part No.	Configuration	Amp Rating
N60070BL	On/Off	20A @ 12V / 10A @ 24V

Toggle Switches Single Pole

A general single-pole all-purpose versatile switch tailored to easily integrate into a variety of different applications.

- Nickel plated brass toggle.
- Suitable for low voltage 12/24V DC.

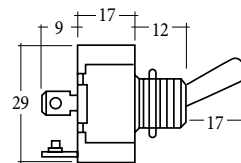

(Dimensions in mm)



Part No.	Configuration	Amp Rating
JPW12701	On/Off	21A @ 12V / 9A @ 24V
JPW12702	On/Off/On	21A @ 12V / 9A @ 24V

Toggle Switch Rubber Boot - Black

- Waterproof rubber boot to suit toggle switches.
- Thread size M12 x 0.75mm.

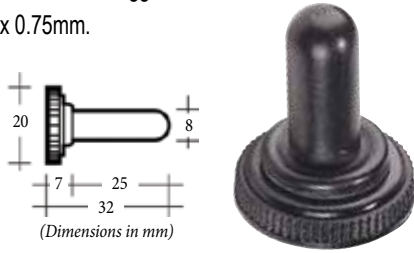

Part No.
JPW12931

(Dimensions in mm)

Narva Switch with Waterproof Neoprene Boot



Momentary (On) heavy-duty push button switch with die-cast housing and waterproof neoprene boot.

- Silver contacts.
- Brass screw terminals.
- Amp rating 60A @ 12V / 30A @ 24V



*Position shown in brackets is momentary action only (not latching)

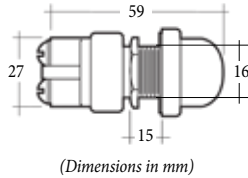

(Dimensions in mm)

Part No.	Switch Configuration
N60033BL	(On)/Off

Narva Marine Ignition Switch - 3 Position



Corrosion proof plastic construction with brass screw terminals.

- Spring return action for start.
- Push for choke function.
- Amperage ratings at 12V, 10A ignition, 5A start, 1A choke.

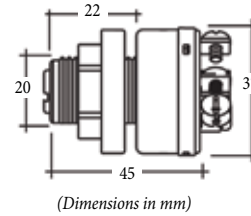

(Dimensions in mm)



Part No.
N64008

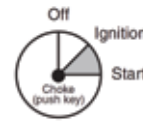

Supplied with two encapsulated keys

Narva Marine Ignition Switch - 4 Position



Heavy-duty brass with screw terminals.

- Spring return action for start.
- Amperage ratings at 12V, 10A accessories, 5A ignition, 5A start.

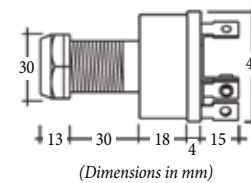
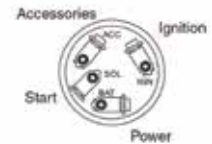

(Dimensions in mm)



Part No.
N64012

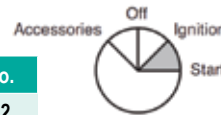

Supplied with two encapsulated keys

Narva Diesel Ignition Switch - 5 Position



A versatile five-position diesel ignition switch with corrosion proof plastic body and spring return action for pre-heat and start.

- Push-on terminals.
- Mounting opening diameter: 26.5mm.
- Amperage ratings at 12V, 8A Park Lamp, 35A Ignition, 60A Pre-heat, 60A Start.

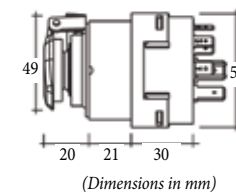

(Dimensions in mm)



Part No.
N64032

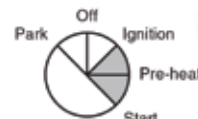

Supplied with two encapsulated keys



Narva Circuit Breakers - High Amp Manual Reset



Sealed for engine compartment or marine applications, with unique reset mechanism providing visible indication of tripped circuit.

- Voltage: 12 - 42V.
- Operating Temperature: -32°C to 82°C



Part No.	Amps
N55960	60A
N55962	80A
N55964	100A
N55966	120A
N55968	150A

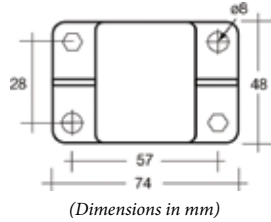

Circuit Breakers - High Amp

Sealed circuit breaker with unique reset mechanism providing a visible indication of a tripped circuit.

- Flush/panel mount or surface mount.
- Sealed outer casing, splash and dust proof.
- Voltage: 12 - 42V.
- Operating temperature: -32°C to +82°C.



JPW12755
Flush / Panel Mount

Part No.	Mount Type	Amps
JPW12753	Panel	60A
JPW12755	Panel	80A
JPW12756	Panel	100A
JPW12757	Panel	120A
JPW12760	Surface	60A
JPW12762	Surface	80A
JPW12763	Surface	100A
JPW12764	Surface	120A



JPW12760
Surface Mount

Quick WCB Hydraulic Magnetic Circuit Breakers



Quick "slow burn" hydraulic magnetic circuit breakers offer protection when using direct currents. In over current situations they will trip, break the circuit and protect the equipment.

- May be reset manually and suitable up to 80V DC.

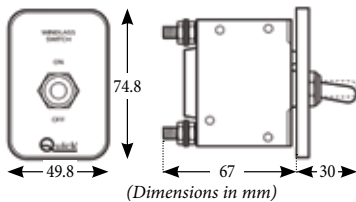

Part No.	Amps
QFDWCB0400000A00	40
QFDWCB0500000A00	50
QFDWCB0600000A00	60
QFDWCB0800000A00	80
QFDWCB1000000A00	100



Magnetic Circuit Breakers 'A-Series' Lever Actuator



Carling A-series circuit breakers have long been recognised as the industry standard in marine circles, used extensively in switchboards and panels by boat and ship builders worldwide.

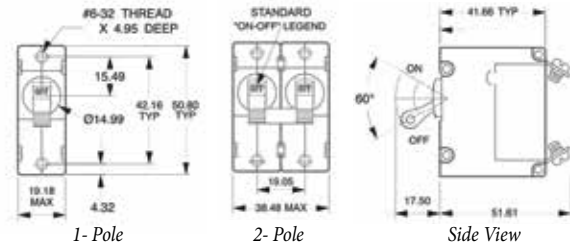

Part No.	Rating	Voltage
----------	--------	---------

Single Pole

JPW12710	2.5A	80VDC / 277VAC
JPW12711	5A	80VDC / 277VAC
JPW12712	10A	80VDC / 277VAC
JPW12713	15A	80VDC / 277VAC
JPW12714	20A	80VDC / 277VAC
JPW12715	25A	80VDC / 277VAC
JPW12716	30A	80VDC / 277VAC
JPW12717	40A	65VDC / 125VAC
JPW12718	50A	65VDC / 125VAC



1- Pole

Double Pole

JPW12719	5A	80VDC / 277VAC
JPW12720	10A	80VDC / 277VAC
JPW12721	15A	80VDC / 277VAC
JPW12722	20A	80VDC / 277VAC
JPW12723	25A	80VDC / 277VAC
JPW12724	30A	80VDC / 277VAC
JPW12725	40A	65VDC / 250VAC
JPW12726	50A	65VDC / 250VAC



2- Pole

Magnetic Circuit Breakers 'M-Series' Paddle Actuator



M-Series 'duck bill' style paddle actuator, single hole panel mounting for quick assembly.

- Fundamental design is simplistic but practical.

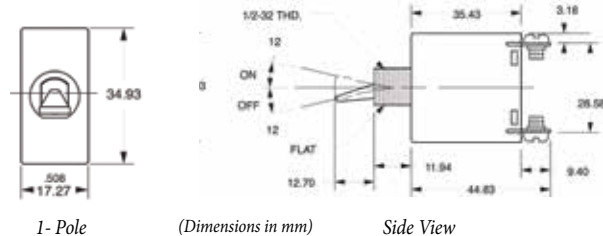

Part No.	Rating	Voltage
JPW12742	5A	32VDC / 250VAC
JPW12743	10A	32VDC / 250VAC
JPW12744	15A	32VDC / 125VAC
JPW12745	20A	32VDC / 125VAC
JPW12746	25A	32VDC / 125VAC



1- Pole

Magnetic Circuit Breakers 'M-Series' Rocker Actuator



M-Series is widely used throughout the marine and transport industry because of their compact design.

- Features a unique dual colour scheme to provide quick recognition when the circuit is 'ON'.
- Snap-in panel mounting requires no fasteners.

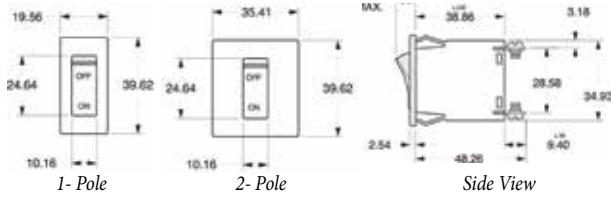

Part No.	Rating	Voltage
----------	--------	---------

Single Pole

JPW12731	5A	32VDC / 250VAC
JPW12732	10A	32VDC / 250VAC
JPW12733	15A	32VDC / 125VAC
JPW12734	20A	32VDC / 125VAC
JPW12735	25A	32VDC / 125VAC

Double Pole

JPW12737	5A	65VDC / 250VAC
JPW12738	10A	65VDC / 250VAC
JPW12739	15A	65VDC / 250VAC
JPW12740	20A	65VDC / 250VAC
JPW12741	25A	65VDC / 250VAC



Thermal Circuit Breakers



The Carling CLB-Series are compact, single pole, push-to-reset thermal circuit breakers.

- Voltage: 48VDC / 250VAC.

JPW12780
Clear silicon boot for switch creates watertight seal



Part No.	Rating (Amps)
JPW12770	3A
JPW12771	5A
JPW12772	10A
JPW12773	15A
JPW12774	20A
JPW12775	25A
JPW12776	30A
JPW12777	35A
JPW12778	40A

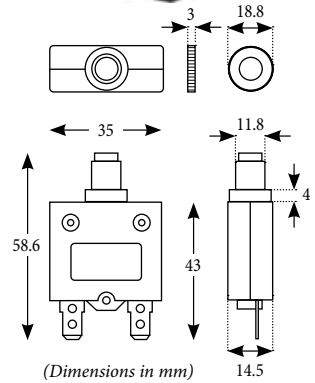

Quick Solenoids and Reversing Solenoids



These replacement contactor and reversing contactor units suit the Quick range of products. Capable of operating electric single or double direction capstan and windlass permanent magnet or series wound motors.

- Straightforward installation due to external connections.
- Rated to 150amps.

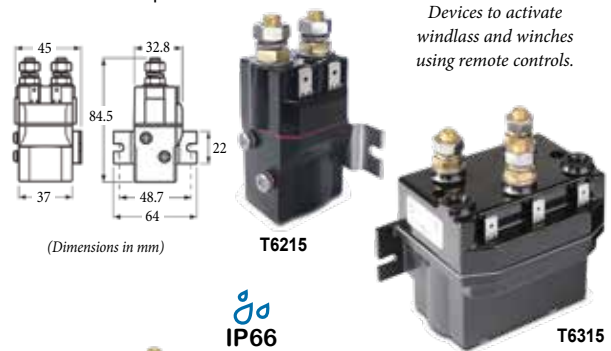

Magnetic Circuit Breakers 'C-Series' Lever Actuator



Carling C-Series circuit breakers are a heavy duty version of the renowned A-Series and are ideal for both switchboard applications and individual branch protection.

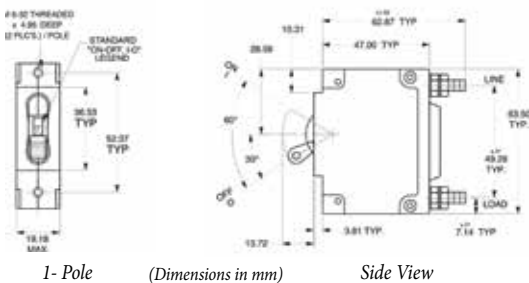

Part No.	Rating	Voltage
JPW12727	60A	80VDC / 250VAC
JPW12728	80A	60VDC / 240VAC
JPW12729	100A	60VDC / 240VAC



Part No.	Model	Type	Volts
QFTT621512000A00	T6215-12	Single	12
QFTT621524000A00	T6215-24	Single	24
QFTT631512000B00	T6315-12	Single	12
QFTT631524000B00	T6315-24	Single	24
QFTT641112000A00	T6411-12	Reversing	12
QFTT6411PT000A00	T6411-PT	Reversing	24
QFTT641512000B00	T6415-12	Reversing	12
QFTT641524000B00	T6415-24	Reversing	24

Single Battery Isolator Switch with Removable Knob

A tough weather resistant single battery isolator switch with tin copper plated studs and nuts, and removable knob.

- Voltage: 12V - 48V.
- 2 position for single battery.
- Removable side panels and back casing.
- Ignition protected.
- Mounting nut and screws supplied.



Part No.	Cont. Rating	Int. Rating	Crank Rating	Dimensions L x W x H (mm)
JPW6135	275A	455A	1250A	68 x 68 x 75

Dual Circuit Battery Isolator Switches - 2 or 3 Position

The design of the case allows for various panel mounting options: surface, rear, or front panel mount.

- Voltage: 32V max.



JPW6138
2 Position



JPW6139
3 Position

Part No.	Pos.	Cont. Rating	Int. Rating	Crank Rating	Dimensions L x W x H (mm)
JPW6138	2	350A	525A	700A	96 x 96 x 80
JPW6139	3	350A	525A	700A	96 x 96 x 80

Single Battery Isolator Switch Heavy Duty

Suited for large vessels, this heavy duty battery isolator switch fits into the same contour lock system as used on battery distribution systems.

- Voltage: 12V - 48V.
- 2 position for single battery.
- Mounting nut and screws supplied.
- Tin copper plated studs and nuts.
- Removable side panels and back casing.
- Ignition protected.



Part No.	Cont. Rating	Int. Rating	Crank Rating	Dimensions L x W x H (mm)
JPW6137	600A	800A	2500A	102 x 102 x 90

Battery Switches with Removable Key

Turn and remove key to isolate electrical system.

- Suitable 12V and 24V applications.
- Rated at: 500A @ 12V.



Part No.	Includes
JPW6129	Key
JPW6130	Key & Rubber Cap

Heavy Duty Battery Master Switch

Heavy duty battery selector switch: 1, 2, both or off positions.

- Suitable for 12V or 24V.
- 300A @ 12V for 5 seconds.
- 175A @ 12V cont. load max.



Part No.	Base Dia (mm)	Height (mm)
JPW6131	135	700

Dual Battery Selector Switch 4 Position

A tough weather resistant compact battery selector switch with four positions for double battery operation. Side panels and back casing can be easily removed for wiring access.

- Voltage: 12V - 48V.
- 4 position operation: 1-2-Both-Off.
- Tin copper plated studs and nuts.
- Mounting nut and screws supplied.
- Ignition protected.



Part No.	Cont. Rating	Int. Rating	Crank Rating	Dimensions L x W x H (mm)
JPW6136	275A	300A	1250A	68 x 68 x 75

Narva Marine Battery Master Switch



Nickel plated with solid copper terminals for superior corrosion resistance. Ideal for automotive and marine applications exposed to salt water and other harsh environmental conditions.

- 1000A @ 12V for 5 seconds.
- 500A @ 24V for 5 seconds.
- 300A @ 12V cont. load max.
- 150A @ 12V cont. load max.

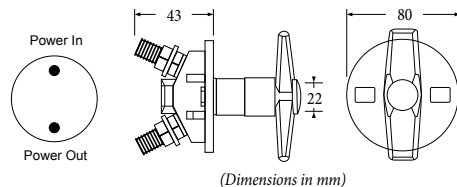

Part No.
N61044BL

Narva Rotary Style Battery Master Switch



Constructed from heavy duty plastic and features brass terminals, making it perfectly suited for applications where the switch is exposed to the weather.

- Suitable for applications up to 48VDC.
- 1500A @ 12V for 10 seconds
- 750A @ 24V for 10 seconds
- 300A @ 12V cont. load max.
- 150A @ 24V cont. load max.

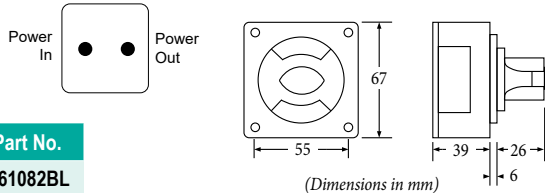

Narva Voltage Sensitive Relays



Automatically connects and disconnects an appliance or circuit at the preset input voltage. Ideal for dual battery systems or to switch high current appliances. Features surge protection, LED indicator and silver tipped contacts for durability and efficiency.

- Weatherproof body (IP65 Rated).
- 12V Cut-in: 13.3V.
- 12V Cut-out: 12.7V (5 second delay).
- 12V @ 160A for 60 seconds.
- 12V @ 140A cont. load max.

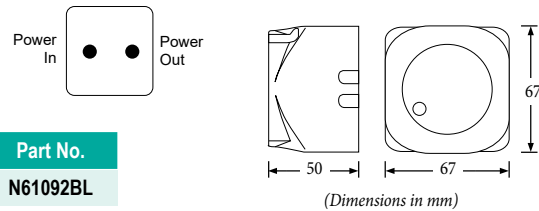

Narva 4-Position Battery Master Switch



This rotary-style battery master switch features brass terminals and heavy-duty plastic construction making it ideal for marine applications.

- 4 position operation: 1-2-Both-Off
- Suitable for applications up to 48V.
- 1500A @ 12V for 10 seconds.
- 750A @ 24V for 10 seconds.
- 300A @ 12V cont. load max.
- 150A @ 24V cont. load max.

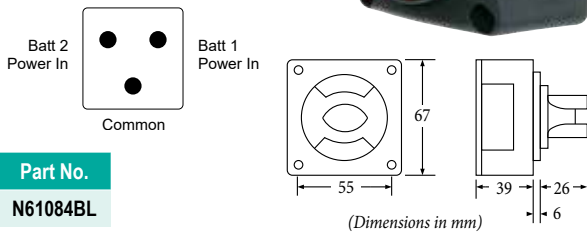

Power Plug and Cigarette Socket

Cigarette lighter plug and socket is suited for exterior or interior use.

- Waterproof rubber cap on socket.
- A green light indication on plug.
- Includes a fuse for increased safety.



Part No.	Base (mm)	Cut Out Dia (mm)
JPW12960	60 x 62	28

Narva Heavy Duty Battery Master Switch



This rotary-style battery master switch with is ideal for heavy duty automotive and marine applications.

- 4 position operation: 1-2-Both-Off
- 500A @ 12V for 5 minutes.
- 250A @ 24V for 5 minutes.
- 310A @ 12V cont. load max.
- 155A @ 24V cont. load max.

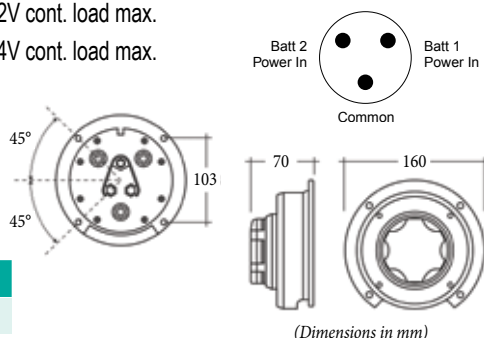

Narva Twin USB Power Adaptor



Ideal for running multiple electronic items, this compact USB adaptor offers a flush factory finish when fitted.

- Illuminated LED fascia.



Part No.	Input	Output
N81039BL	12/24V	5V / 2.5A

USB Dual Port Socket Rocker Switch Style

High current, dual USB socket with Blue LED indicator.

- Waterproof with PVC mounting gasket seal and dust cover
- Input voltage: 12/24V.
- Output: 4.8A @ 5V (2.4A per port).



Part No.	Ports
JPW12588	2x USB-A
JPW12589	1x USB-A & 1x UBS-C

Scanstrut ROKK Charge+ Waterproof Dual USB-A Socket

This ultimate rapid charge socket has 2x USB Type-A charging ports and will charge devices up to 3x faster than standard USB sockets.

- Standard USB mounting hole: ø29mm.
- Ultra-low profile design with click-and-lock lid.
- Output current: 4.2A (total)
- Voltage: 12/24V



Part No.	Dimensions L x W x H (mm)
JPW10509	94 x 39 x 47

Scanstrut Flip Pro Max Dual USB-C Socket

Super compact 2x USB-C charging port, ultra-low profile design with spring loaded cap. Supplied with an optional front fit bezel.

- Splashproof design (when lid is closed).
- Mounting hole: ø32mm.
- USB-C output: 60W max on 24V system
36W max on 12V system
- Voltage: 12/24V



Part No.	Dimensions L x W x H (mm)
JPW10513	68 x 51 x 81 (with bezel)

Scanstrut ROKK ChargePro Waterproof Dual USB-A & USB-C Socket

Ultimate onboard USB charger, featuring 1x USB-A and 1x USB-C charging port.

- Standard USB mounting hole: ø29mm.
- Ultra-low profile design with click-and-lock lid.
- USB-A output: 36W max
- USB-C output: 60W max on 24V system
36W max on 12V system
- Voltage: 12/24V



Part No.	Dimensions L x W x H (mm)
JPW10510	94 x 39 x 47

Scanstrut Flip Pro Power Socket 12V

Featuring a spring loaded lid and an impressive 150W max power on a 12V system. Supplied with an optional front fit bezel.

- Splashproof design (when lid is closed).
- Mounting hole: ø32mm.
- Red LED running light.
- Input voltage: 12V system.
- Input Current: 10A.
- Type-C 12V system output:
5V @ 5A / 9V @ 3A / 12V @ 3A max



Part No.	Dimensions L x W x H (mm)
JPW10515	68 x 51 x 62 (with bezel)

Scanstrut Flip Pro Dual USB Socket

Super compact 1x USB-A and 1x USB-C charging port, ultra-low profile design with spring loaded cap.

- Splashproof design (when lid is closed).
- Standard USB mounting hole: ø29mm.
- USB-A output: 36W max
- USB-C output: 60W max on 24V system
36W max on 12V system
- Voltage: 12/24V



Part No.	Dimensions L x W x H (mm)
JPW10511	38 x 39 x 18

Scanstrut Flip Pro Multi USB & 12V Power Socket

Combining features of the high power Flip Pro USB with a 12V Power Socket. When not in use, the spring-loaded caps remain tightly closed, protecting the ports from the elements.

- Supplied with an optional front fit bezel.
- 120W -150W max power 12V system only.
- Input current max: 6A (10A fuse recommended).
- Input voltage: USB charger - 10-32V DC (12/24V System).
12V socket - 10-15V DC (12V System).



Part No.	USB Type
JPW10514	2x USB-C
JPW10517	1x USB-A & 1x USB-C



Scanstrut Flip Pro Dual USB Socket with Bezel

Same features as JPW10511 above, but with a front bezel for when installation is not possible behind panels.



Part No.	Dimensions L x W x H (mm)
JPW10512	63 x 46 x 18



Narva Single Power Accessory Sockets - Flush Mount



Heavy duty flush mount power sockets with rubber dustproof and splashproof protected covers. The fitting mechanism allows installation into interior or exterior panels including steel and aluminium.

- Can be installed with or without the mounting panel.



N81026BL

N81132BL



N81135BL

N81134BL

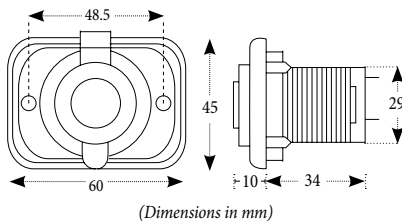

Part No.	Type	Specifications
N81026BL	Cigarette Lighter Socket	20A @ 12V / 10A @ 24V
N81132BL	Engel Type Socket	20A @ 12V / 10A @ 24V
N81134BL	Dual USB-A Socket	Voltage: 5V / Amp: 2.5A
N81135BL	LED Volt Meter	Range: 6-33V

Narva Double Power Accessory Socket Panels - Flush Mount



Same as above, combined into dual flush mount panels.



N81141BL

N81144BL

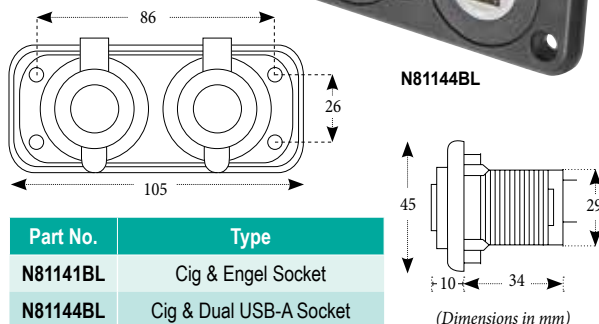

Part No.	Type
N81141BL	Cig & Engel Socket
N81144BL	Cig & Dual USB-A Socket

Narva Power Triple Accessory Socket, Dual USB and Volt Meter - Flush Mount



Three accessories combined into one flush mount panel.

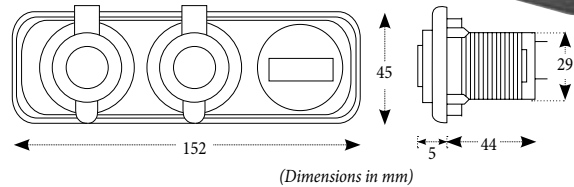

Part No.	Accessory Amp Rating	USB Output	Volt Range
N81181BL	20A @ 12V / 10A @ 24V	5V, 2.5A	6-33V

Narva Sockets - Surface Mount



Features dust-proof cover and stylish surface mount plastic housing. For exterior applications, mount the housing with the opening facing down.



N81025BL

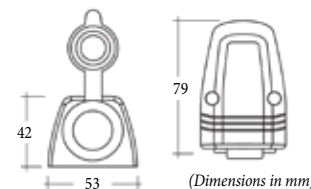

N81152BL

Part No.	Socket Type	Amp Rating
N81025BL	Accessory	20A @ 12V / 10A @ 24V
N81152BL	Engel	15A @ 12V / 7.5A @ 24V

Narva Double Power Accessory and Dual USB-A Socket - Surface Mount



Includes dustproof covers and stylish surface mount plastic housing.

- Easy installation to interior or exterior panels.

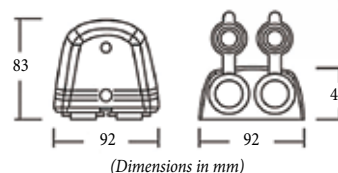

Part No.	Accessory Amp Rating	USB Output
N81168BL	20A @ 12V / 10A @ 24V	5V, 2.5A

Narva Anderson Connectors - Flush Mount



Heavy duty flush mount Anderson Connectors with rubber dustproof and splashproof protected cover.

- Stylish fascia plate conceals mounting screws.
- Anderson connector output: 5V, 2.5A.



Part No.	Type
N81110BL	Single Anderson Connector
N81146BL	Anderson Connector & Dual USB-A Socket
N81151BL	Anderson Connector & Engel Socket
N81153BL	Anderson Connector & Volt Meter

Anderson Plug Battery Connectors

Connector with impact resistant polycarbonate housing

- Includes 2x silver plated solid copper terminals.



Part No.	Amp Rating	Suits Cable Size
JPW12940	50A	8mm ² (8 B&S)
JPW12941	175A	32mm ² (2 B&S)

Quick Watertight Cable Outlets



Black plastic electrical cable gland used when running cables throughout your boat. Protects against corrosion and humidity and keeps a watertight seal where cables run from wet into dry areas.

- Includes cable base, cap, rubber gasket to seal and 3x stainless steel fixing screws.



Part No.	Suits Cable Size (mm)
QFC8111000000A00	5 - 10
QFC8113000000A00	7 - 12
QFC8116000000A00	10 - 14



Quick Watertight Electrical Connectors



Fully waterproof plastic deck mounted plug and socket connectors.

- Gold plated contacts produce a high current rating and low resistance.
- Comes complete with plug and socket, choice of 3 different size cable gaskets, screw tight cap with rubber gasket plus 4 fixing screws.
- Length x Dia: 86 x 46mm



Part No.	Voltage	Model	Poles	Amps
QFC7103000000A00	48	7103	3	12A
QFC7105000000A00	48	7105	5	7A
QFC7106000000A00	48	7106	6	6A
QFC7107000000A00	48	7107	7	5A
QFC7108000000A00	48	7108	8	4A
QFC7109000000A00	48	7109	9	4A
QFC7110000000A00	48	7110	10	3A
QFC7112000000A00	48	7112	12	3A

Scanstrut Watertight Vertical Entry Cable Seals



Waterproof range of cable seals provide easy fit cable routing that cuts down your installation time. Captive nuts make for simple assembly and also allow reliable repeat installations.

- UV-stable and hard-wearing materials.
- Pre-drilled, blank and split bungs included.



Stainless Steel (cable not included)



Black

Part No.		Cable Size (mm)	Connector Size up to (mm)	Dimensions Dia x H (mm)
Black	Stainless Steel			
JPW10427	-	2-6	6	30 x 17
JPW10412	JPW10413	2-8	16	39 x 19
JPW10415	JPW10416	4-9	21	49 x 20.5
JPW10418	JPW10419	9-14	21	49 x 20.5
JPW10421	JPW10422	9-14	30	59 x 20.5

Scanstrut Watertight Horizontal Entry Cable Seals



Single or double horizontal cable seals eliminates time-consuming, sub-standard routing of cables and messy sealant. Captive nuts make for simple assembly and also allow reliable repeat installations.

- UV-stable and hard-wearing materials.
- Black high impact plastic.



JPW10432



JPW10429



JPW10433
JPW10430

Part No.	Type	Cable Size (mm)	Dimensions L x W x H (mm)
JPW10432	Single	2 - 6	28.5 x 46 x 20
JPW10433	Double	5 - 6	54 x 63 x 22
JPW10429	Single	6 - 10	44.5 x 77.5 x 27
JPW10430	Double	6 - 10	66.5 x 75 x 28.5

Monocrystalline Soft Folding Solar Panel Kit



Compact, powerful and ready to use, this lightweight kit features scratch resistant panels, LED indicators and 5m lead and battery clips.

- Discharge protection protects your battery from discharge at night.
- Multi charging protects against reverse polarity, short circuit, over temperature, over voltage, etc.
- Includes metal support legs, collapsible tent pole and reinforced eyelets for setting up.
- Charge time: 7 - 35 hours.



Heavy duty canvas with front storage pocket



Part No.	Voltage	Power	Dimensions L x W x H (mm)
NSPM120K	12V	120W	2190 x 500 x 45

Scanstrut Watertight Multiple Vertical Entry Cable Seals



Designed to provide a quick and easy installation for multiple cables up to 15mm (each).

- Supplied with an un-drilled seal for customised drill holes.
- UV-stable and hard-wearing materials.



JPW10434
(cables not included)



JPW10435



Part No.	Material	Dimensions L x W x H (mm)
JPW10434	Aluminium	99 x 47.5 x 17
JPW10435	Black Plastic	105 x 53.5 x 23

TotalCool Portable Foldable Solar Panel



Built to use outdoors or on the dash of your vehicle. Features a USB Type A socket, USB Type C socket and DC port for direct charging.

- High efficiency sun power cells.
- Lightweight, foldable and portable (3.6kg).
- Water resistant.



Folds down with handle & front pocket



Part No.	Voltage	Power	Dimensions L x W x H (mm)
JPW88024	12V	100W	1500 x 425 x 5

Scanstrut ROKK Qi 10W Wireless Phone Chargers

Wireless charge systems housed in a fully encapsulated and sealed unit, without the need for phone charging cables.

- Marine-grade materials.
- For internal and external use.
- Wattage: 10W
- Voltage: 12/24V



NEW 2023



JPW10495 Hidden



JPW10496 Surface



JPW10497 Active



JPW10498 Edge



JPW10499 Nest



JPW10500 Sub



JPW10501 Catch



JPW10504 Nano



JPW10502 Cove



JPW10503 CoveLED

Part No.	Model	Dimensions L x H x D (mm)
JPW10495	Hidden	ø 100 x 14
JPW10496	Surface	ø 98 x 17
JPW10497	Active	74 x 206 x 33
JPW10498	Edge	74 x 206 x 77
JPW10499	Nest	142 x 106 x 182
JPW10500	Sub	ø 98 x 17
JPW10501	Catch	118 x 206 x 16.5
JPW10502	Cove	218 x 124 x 118
JPW10503	CoveLED	218 x 124 x 118
JPW10504	Nano	130 x 72 x 34

Dolphin Pro Touch Battery Chargers

AC/DC battery chargers feature a TOUCHVIEW screen and integrated control panel to display the charging curve and warn you of any alarms. These chargers are ultra protected for output overload and short-circuit, internal overtemp, overvoltage and reverse polarity (fuse).



- Compatible with most of battery types including Lithium Ion LFP.
- Smart 3 stages charging characteristics.
- Standard CANbus J1939 interface.
- NMEA-Ready (can be connected to any modern onboard system).
- Deliver full power even at very high temperatures.
- Solid 100% high-grade aluminium casing.

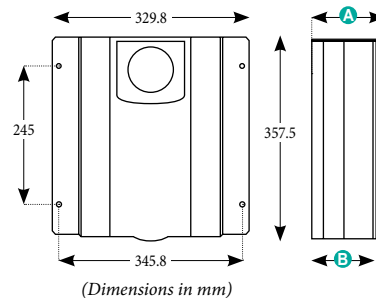

Part No.	Volts	Amps	Dimensions (mm)	
			A	B
JPW12694	12	90	127.70	113.20
JPW12695	24	40	127.70	113.20
JPW12696	24	60	127.70	113.20
JPW12697	24	80	127.70	113.20
JPW12698	24	100	196.20	182.90

Dolphin Pro-Lite Battery Chargers

The best smart, silent, compact and waterproof charger on the market.

- Perfect choice for sailboats, center console boats, sport fishing boats and other pleasure craft.
- Fan-less and ignition-protected Bluetooth power units.
- 40% smaller and 50% lighter than previous models.
- Protected against ignition of flammable gases.
- Dust-tight and water resistant.

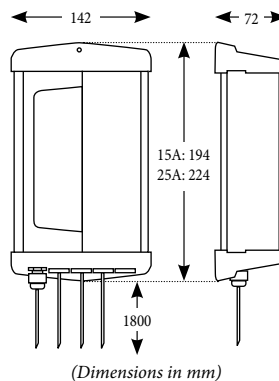

JPW12678



JPW12679

Part No.	Volts	Amps
JPW12678	12	15
JPW12679	12	25

Projecta Lithium Battery 12V 100A



Lithium iron phosphate technology gives the advantage of high specific energy, long cycle life, high safety, low self-discharge and low weight.

- M8 bolts provide high current transfer ideal for parallel battery setups.
- Standard size - ideal for most N70 size battery boxes.
- Power up to 1000W inverters.
- Carry strap for easy transporting.
- Nominal voltage: 12.8V.
- Discharge current: 100A.



Part No.	Dimensions L x W x H (mm)
NLB100	327 x 172 x 218

Projecta 12V 1500W Pure Sine Wave Inverter with Remote Control Display



Power some demanding 240V appliances on the go, including circular saws, electric irons, angle grinders and coffee machines.

- Designed in accordance with Australian Standards.
- Residual Current Device (RCD) safety switch.
- Thermostatically controlled cooling fan.
- Low/high input voltage, low battery alarm, over temperature and overload protection.
- Fully isolated design.
- Remote control display.
- Bi-colour LED display.



Part No.	Dimensions L x W x H (mm)
NIP1500	327 x 172 x 218

Projecta Lithium Battery with Bluetooth Monitoring 12V 150A



The top-mounted battery indicator provides state of charge, warning and bluetooth connectivity at the touch of a button.

- M8 bolts provide high current transfer ideal for parallel battery setups.
- Bluetooth battery monitoring via smart phone/tablet app.
- Standard size - ideal for most N70 size battery boxes.
- Sleep mode to reduce residual power consumption
- Power up to 2000W inverters.
- Battery indicator & button.
- Nominal voltage: 12.8V.
- Discharge current: 150A.



Part No.	Dimensions L x W x H (mm)
NLB100-BT	330 x 175 x 195

Projecta Lithium Battery 100A with DC Charger Kit



Lithium battery and charger kit uses advanced lithium battery technology.

Kit includes:

- 1x NLB100 Lithium Battery 12V 100A.
- 1x NIDC25L 5 Stage Intelli-Charge 9-32V Lithium Dual Battery Charger.



Part No.
NLB100-K

Projecta 5 Stage Intelli-Charge 9-32V Lithium Dual Battery Charger



An advanced dual DC/solar battery charger engineered for todays sophisticated lithium iron phosphate batteries.

- Power supply: constant voltage of 13.8 volts.
- Remote charger status indication.
- Dust, splash and shock proof.
- Superior 5 stage charging.
- Switchmode technology.
- Dual input operation.



Part No.	Dimensions L x W x H (mm)
NIDC25L	122 x 150 x 40

Projecta Lithium Battery 150A Bundle with Inverter & Charger



Uses advanced lithium battery technology, ideal for boats, 4WDs and caravans with high power demands.

Kit includes:

- 1x NLB100-BT Lithium Battery with Bluetooth Monitoring.
- 1x NIDC25L 5 Stage Intelli-Charge Lithium Dual Battery Charger.
- 1 x NIP1500 Pure Sine Wave Inverter with Remote Control Display



Part No.
NLB100-BT-K

Intelli-Start Lithium Emergency Jumpstarter and Power Bank **PROJECTA**

Powerful and compact high performance jumpstarter in an ultra compact and lightweight package, capable of starting most petrol engines.

- 40 seconds of Rapid Recharge after each jumpstart.
- Ultra-safe Lithium Iron Phosphate (LiFePO₄) battery.
- Power bank functionality.
- 12V Output.



Built in LED flood light



IP53

Part No.	Emergency Jumpstarts		Suits Vehicles	
	Petrol	Diesel	Petrol	Diesel
NIS920	14	0	6.0L	0
NIS1220	68	34	7.0L	4.5L

Charge N Maintain Automatic Battery Chargers - 12V **PROJECTA**

Fully automatic battery chargers offering a safe and practical method for charging all your 12V automotive and marine batteries.

- Spark-free and polarity protected.
- 4-stage or 8-stage charging.
- Switchmode technology.

IP65



Interactive LCD screen (8-stage chargers only)



NAC008

Part No.	No. of Stages	Amps	Dimensions L x W x H (mm)
NAC008	4	0.8	150 x 70 x 45
NAC015	4	1.5	150 x 70 x 45
NAC040	8	4	225 x 90 x 60
NAC080	8	8	225 x 95 x 68

Battery Boxes

Quality, vented, marine battery boxes manufactured from high density reinforced polyethylene, which is impervious to battery acids.

- Includes sturdy carrying handles, two vents and the lid has four recesses to allow for cable entry.
- Also supplied complete with strap, mounting cleats and stainless steel fastenings.



Part No.	Overall L x W x H (mm)	Base L x W (mm)	Inside L x W x H (mm)
JPW6124	330 x 230 x 260	285 x 195	275 x 190 x 195
JPW6125	417 x 230 x 285	340 x 195	335 x 190 x 220
JPW6126	455 x 235 x 260	400 x 195	390 x 185 x 200

Battery Boxes with Power Socket and Battery Tester

Boat battery box with in-built dual USB or conventional cigarette socket.

- The battery condition indication on lid.
- Pre-wired positive and negative external battery terminals.
- Includes adjustable strap with mounting bracket.
- 10amp fuse for accessory sockets.
- 30amp fuse for battery overload.
- Overall LxWxH: 410x230x300mm
- Base LxW: 345x198mm
- Inside LxWxH: 340x190x225mm



Carry Handle



Cig Accessory Power Sockets with rubber cap



JPW6133
Dual USB charging with rubber cap

Part No.	Accessory Type
JPW6123	2x Cig Sockets
JPW6133	1x USB & 1x Cig Socket

Battery Tray Tie Down Straps

Replacement straps with mount hardware.



Part No.	Suits Battery Box Part No.	Strap Length (m)
JPW6127	JPW6124	1m
JPW6128	JPW6123, JPW6133, JPW6125, JPW6126	1.3m



Heavy Duty Battery Trays

Made from heavy duty non-corrosive black injection moulded plastic, this tray protects the hull and secures the battery in place.

- Includes an adjustable height top frame.
- Stainless steel retaining bolts secured tight with nylon thumb screws.
- Battery height (min-max): 165-210mm.



Part No.	Overall Size L x W x H (mm)	Max. Battery Base L x W x H (mm)
JPW6099	325 x 190 x 225	260 x 170 x 200
JPW6100	365 x 190 x 225	300 x 170 x 200

Battery (Master) Terminal

Brass battery terminal with a quick release knob to disconnect battery power.

- Simple to use.



Part No.

JPW6119

Zinc Plated Battery Terminals

Battery terminals with brass wing nuts and tapered post.

- Holes marked with (+) and (-).
- Sold in pairs.



Part No.

JPW6115

Battery Holder Trays

All parts of this product are made of non-corrosive black polyethylene which is impervious to battery acid. These battery trays protect the hull and secure the battery in place.

- Available to suit most marine size batteries.



Part No.	Max. Battery Base L x W x H (mm)
JPW6101	280 x 180 x 245
JPW6102	320 x 180 x 245

Brass Battery Terminals

Economically priced battery terminals with tapered post.

- Holes marked with (+) and (-).
- Hang packed in pairs.



Part No.

JPW6120

Quality Brass Battery Terminals

Marine battery terminals with coloured wing nuts.

- Precision moulded from powdered brass.
- Sold in pairs.



Part No.

JPW6122

Battery Tie-Down - Stainless Steel

Strong, non-corrosive 304-grade stainless steel battery fastener to suit standard size batteries.



Part No.	Max. Battery Width (mm)	Battery Height (mm)
JPW6104	190	180 - 225



Battery Terminals - Bronze Plated

Precision moulded from powdered brass with bronze plating designed for optimum fit.

- Supplied as a blister pack pair.



Part No.

JPW6116

Battery Tray with Straps

Made of non-corrosive black polyethylene, which is impervious to battery acid.

- Includes strap, screws and bolts.



Part No.	Max. Battery Base L x W x H (mm)
JPW6103	315 x 180

Unilug Dual Battery Terminals

Two Up battery terminal lugs purpose designed for dual battery installations.

- Includes: Lug assembly, adaptor post and protective cover.



Part No.

JPW6117 Positive

JPW6118 Negative

JPW6117

JPW6118

Narva Glass Fuses - 3AG



Available blister packs for retail or bulk for trade.

- Internal soldered cap.

Part No.		Amps
Blister Pk (Qty: 5)	Box of 10 (Qty: 50)	
N52301BL	N52301	1A
N52302BL	N52302	2A
N52303BL	N52303	3A
N52305BL	N52305	5A
N52307BL	N52307	7.5A
N52310BL	N52310	10A
N52315BL	N52315	15A
N52320BL	N52320	20A
N52325BL	N52325	25A



Standard ATS Blade Fuses



Standard blade fuses are the most common of the blade fuse type.

- Available in packs of 50 or convenient blister pack of 5.

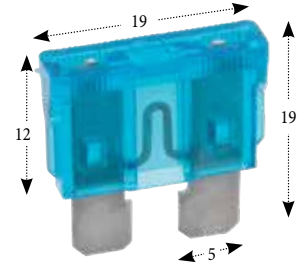

Part No.		Amps	Colour
Pack of 5	Box of 50		
N52803BL	N52803	3A	Purple
N52805BL	N52805	5A	Orange
N52807BL	N52807	7.5A	Brown
N52810BL	N52810	10A	Red
N52815BL	N52815	15A	Blue
N52820BL	N52820	20A	Yellow
N52825BL	N52825	25A	White
N52830BL	N52830	30A	Green
N52840BL	N52840	40A	Brown

Quick CNL Fuses



CNL DIN replacement fuses to suit Quick the range of bow thrusters.

Part No.	Amps
QFVEFF125CNLDA00	125A
QFVEFF150CNLDA00	150A
QFVEFF175CNLDA00	175A
QFVEFF200CNLDA00	200A
QFVEFF225CNLDA00	225A
QFVEFF250CNLDA00	250A
QFVEFF275CNLDA00	275A
QFVEFF325CNLDA00	325A
QFVEFF350CNLDA00	350A
QFVEFF400CNLDA00	400A
QFVEFF500CNLDA00	500A



Narva Fuse Assortment Case



This transparent plastic case with 18 sections contains 360 popular glass, mini blade and standard ATS blade fuses. A base label identifies the fuse with a graphic image, part number and description to make re-ordering easy.

- Comprises of:

Mini Blades	Standard Blades	Glass 3AG Fuses
7.5A x 20	5A x 20	5A x 20
10A x 20	10A x 40	10A x 20
15A x 20	15A x 40	15A x 20
20A x 20	20A x 20	20A x 20
25A x 20	25A x 20	
30A x 20	30A x 20	



Part No.
N52020



Viper Pro Series Blade Fuses with LED Indicator



If the fuse is blown, it will light up to easily identify and replace, eliminating the need for a multi-meter.

- Sold in clear plastic boxes of 30.
- Conveniently colour coded.

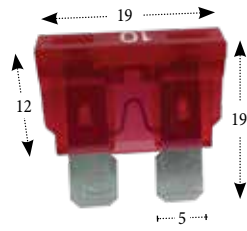

(Dimensions in mm)

Part No.	Amps	Colour
JPW12984	3A	Purple
JPW12985	5A	Orange
JPW12986	7.5A	Brown
JPW12987	10A	Red
JPW12988	15A	Blue
JPW12989	20A	Yellow
JPW12990	25A	Clear
JPW12991	30A	Green



In-line Fuse Holders with Water Resistant Cap

Weather resistant in-line fuse holder suits auto type ATS blade fuses.

- Use on circuits with a low amperage 5-10Amps max.
- For wire size gauge between 16-18AWG.



JPW12996



JPW12995

Part No.	Cap Colour
JPW12995	Red
JPW12996	Black

Viper Pro Waterproof Blade Fuse Holder With Transparent Cap



Heavy duty waterproof marine blade fuse holder with transparent orange sealed cap that locks closed.

- Includes a molded mounting tab for easy installation.
- Accepts a single standard blade fuse up to 30A.



Part No.
JPW12994

NARVA Weatherproof ATS Blade Fuse Holder



Standard in-line fuse holder, features a weatherproof cap.

- Amperage rating 30A.



Part No.	Type
N54406	Bag Pack 1
N54406-10	Bulk Pack of 10

NARVA Pre-Wired ATS Blade Fuse Holder



- Waterproof standard in-line fuse holder.
- Amperage rating 30A.



(Fuse not included)

Part No.	Type
N54405BL	Blister Pack
N54405-10	Bulk Pack of 10

Viper Pro Blade Fuse LED Indicator Kit - 242 Piece



A transparent plastic case with 9 sections contains 242 blade fuses with LED indicator and two waterproof in-line blade fuse holders. A label on the top of the case identifies the fuse with a part number and description to make re-ordering easy.

- Comprises of:

Standard Blade Fuses

3A x 30	15A x 30
5A x 30	20A x 30
7.5A x 30	25A x 30
10A x 30	30A x 30

Blade Fuse Holder x 2



Part No.
JPW12983

NARVA In-Line ANL Fuse Holder



Transparent cover and rubber grommets to securely retain square fuses.

- No fuse supplied.

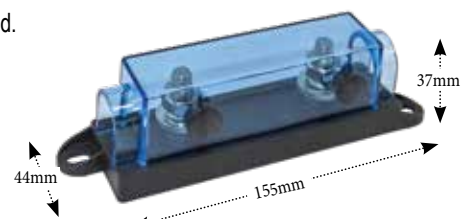

Part No.
N54419

Narva ATS Blade Fuse Box



- Standard ATS blade fuse box with transparent cover and gasket.
- Suitable for lateral connection with female 6.3mm blade terminals.
- Amperage rating 30A per circuit at 12V.

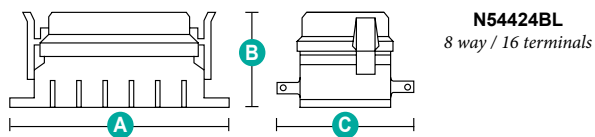

Part No.	Type	Dimensions (mm)		
		A	B	C
N54422BL	6-Way	100	37	45
N54424BL	8-Way	120	37	45

Narva Fuse Blocks with Transparent Cover



Standard ATS blade fuse block with transparent cover and single power-in terminal.

- Amperage rating 25A per circuit at 12V, 150A max per block.

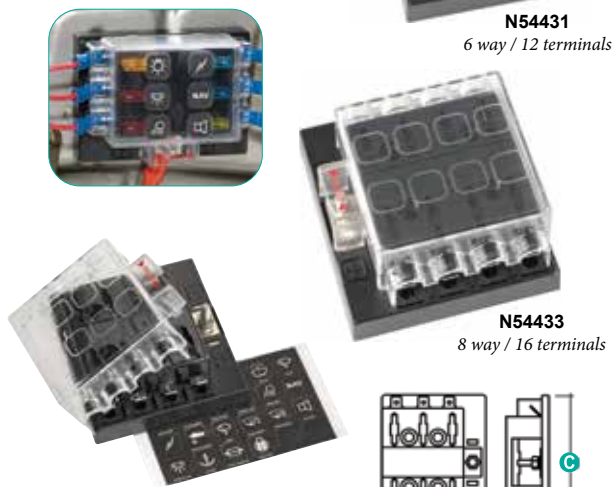

Includes circuit identification stickers for commonly fused accessories.

Part No.	Type	Dimensions (mm)		
		A	B	C
N54431	6-Way	67	40	93
N54433	8-Way	83	40	93

Narva ATS Blade Fuse (Plug-In Type Circuit Breaker Block) '12-Way' Standard



A professional fuse box eliminates extensive and messy wiring in applications with limited earth connections such as caravans, motor homes and marine applications.

- Suitable for use with ATS blade fuses and plug-in circuit breakers.
- Includes 84 labels to suit commonly used accessories.
- Lockable transparent cover.
- Max Amps per circuit: 30A at 12V.
- Max Amps per block: 120A at 12V.
- Max voltage: 32V DC.
- Multiple earth returns.
- Single grounding terminal.
- Dual power input terminals.

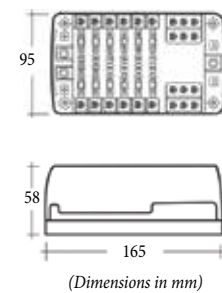

Part No.
N54450BL

Fuse Box with Fuses 12-way

Standard ATS blade fuse or plug-in type circuit breaker (12-way) with transparent cover and indication lights for when fuse is broken.

- Negative bar.
- 12 x fuses (3x 5A / 3x 10A / 3x 15A / 3x 20A).
- Mounting screws supplied.

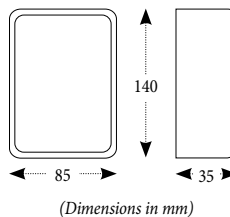
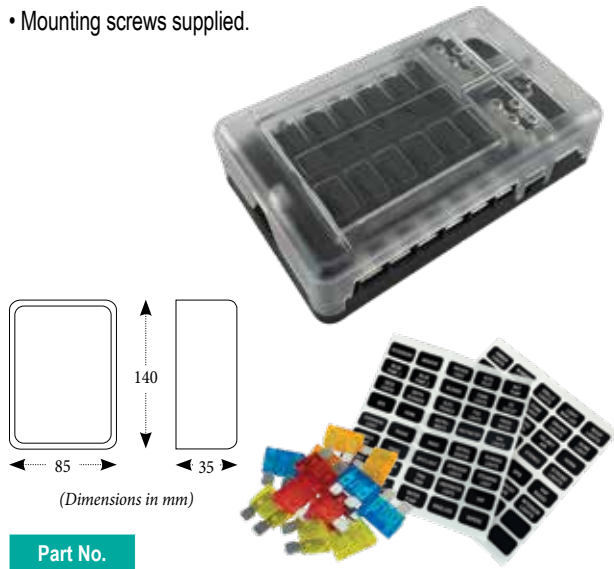

Part No.
N57810

Includes 80x identification stickers and 12x fuses.

Bus Bar Power Distribution Terminal Blocks

Nylon base with raised brass bar, recessed mounting holes and removable polycarbonate cover.

- Continuous Rating: 130AAC / 150A DC
- Max Voltage: 300V AC / 48V DC



Part No.	Base Type	Positions	Terminal Screws	Terminal Studs
JPW12661	Solid	4	M6	M6
JPW12662	Solid	2 x 4	M6	M6
JPW12663	Open	2 x 4	M6	M6
JPW12664	Open	2 x 6	M4	M6



Narva Deutsch Connectors - 2-way Female/Male

This high end connector is specifically suited to the marine, mining and transport sectors where the slightest degradation in connection is critical. Thermoplastic (-55°C to +125°C rated) housings and silicone seals ensure protection from extreme temperatures and excessive moisture.

- Weatherproof connectors with terminals, wedge and seals.
- Amp rating: 13A

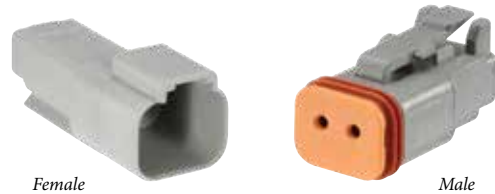

Part No.	Description
N57422BL	2-Way Blister pack - 1 Female and 1 Male

Narva 8-Way Weatherproof Junction Box



Constructed of electrically insulated rubber with transparent cover for easy inspection. Four cable entry points can be cut to size to suit various cable diameters up to 6mm.

- Amp rating: 30A per circuit.

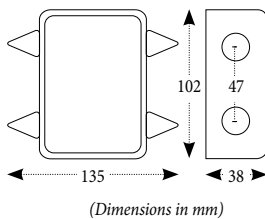

Part No.
N57810



Narva 12-Way Junction Box



Constructed from heavy-duty plastic with four cable entry points and convenient removable blade terminal block.

- Access to the internals is easy via four knurled screws that don't require tools.
- Silicone gasket embedded within the lid ensures a tight weatherproof seal.
- Suits cables up to 6mm.
- Amperage rating: 30A per circuit.

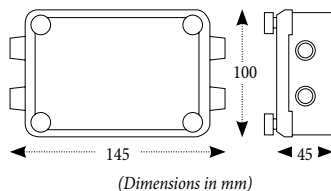

Part No.
N57820



Narva Terminals and Connectors

Flared vinyl insulated, high heat resistant and conveniently colour-coded.

Male Bullet Terminals

Part No.	Qty (per pack)	Wire Size (mm)	Pin Dia (mm)	Colour
N56146	100	2.5 - 3	4	Red
N56148	100	4	5	Blue
N56155	50	5 - 6	5	Yellow

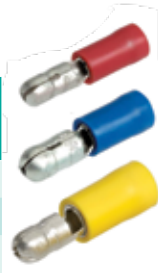

Female Bullet Terminals

Part No.	Qty (per pack)	Wire Size (mm)	Pin Dia (mm)	Colour
N56150	100	2.5 - 3	4	Red
N56152	100	4	5	Blue
N56157	50	5 - 6	5	Yellow



Cable Joiners

Part No.	Qty (per pack)	Wire Size (mm)	Colour
N56154	100	2.5 - 3	Red
N56054	15	2.5 - 3	Red
N56156	100	4	Blue
N56056	14	4	Blue
N56158	100	5 - 6	Yellow
N56058	8	5 - 6	Yellow



Male Blade Terminals

• Tab size: 6.3 x 0.8mm

Part No.	Qty (per pack)	Wire Size (mm)	Colour
N56120	100	2.5 - 3	Red
N56122	100	4	Blue
N56124	100	5 - 6	Yellow



Female Blade Terminals

• Tab size: 6.3 x 0.8mm

Part No.	Qty (per pack)	Wire Size (mm)	Colour
N56134	100	2.5 - 3	Red
N56136	100	4	Blue
N56138	100	5 - 6	Yellow



Female Blade Terminals - Fully Insulated

• Tab size: 6.3 x 0.8mm

Part No.	Qty (per pack)	Wire Size (mm)	Colour
N56142	100	2.5 - 3	Red
N56144	100	4	Blue



Ring Terminals - Red

• Wire size: 2.5 - 3mm

Part No.	Qty (per pack)	Tab Dia. (mm)
N56169	100	3
N56069BL	25	3
N56170	100	4.3
N56070BL	25	4.3
N56172	100	5
N56072BL	25	5
N56174	100	6.3
N56074BL	16	6.3
N56175	100	8.4
N56075BL	16	8.4



Ring Terminals - Blue

• Wire size: 4mm

Part No.	Qty (per pack)	Tab Dia. (mm)
N56176	100	4.3
N56076BL	25	4.3
N56178	100	5
N56078BL	25	5
N56180	100	6.3
N56080BL	20	6.3
N56182	100	8.4
N56082BL	14	8.4
N56183	100	9.5
N56083BL	12	9.5



Ring Terminals - Yellow

• Wire size: 5 - 6mm

Part No.	Qty (per pack)	Tab Dia. (mm)
N56184	100	4.3
N56084BL	14	4.3
N56186	100	5
N56086BL	14	5
N56188	100	6.3
N56088BL	12	6.3
N56190	100	8.4
N56090BL	10	8.4
N56192	100	9.5
N56092BL	10	9.5
N56193	100	13
N56093BL	12	13



Narva Solder Splice Terminators

Solder splice terminators combine all the advantages of heatshrink, low-melt solder and waterproofing protection glands. This creates a fast, waterproof, electrically reliable and fully insulated connection without the use of a soldering iron, crimping tool or solder.

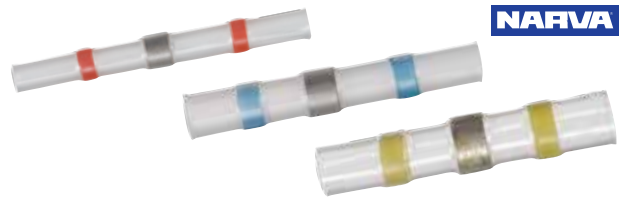

Part No.	Qty (per pack)	Wire Size (mm)	Colour
N56380	25	1.5 - 2.5	Red
N56380BL	5	1.5 - 2.5	Red
N56382	25	2.5 - 4.5	Blue
N56382BL	5	2.5 - 4.5	Blue
N56384	25	4.5 - 6	Yellow
N56384BL	5	4.5 - 6	Yellow



Narva Heatshrink Terminals



The internal adhesive of the heatshrink terminals bonds securely to both the terminal and cable. Creates a level of strain relief not achievable with standard terminal types. The shrink/adhesive combination also produces a seal that prevents water and dust getting into the back of the terminal.

- Transparent, heat shrinkable, high density polyolefin.
- Conveniently colour-coded.
- Adhesive lined.

Cable Joiners

Part No.	Qty (per pack)	Wire Size (mm)	Colour
N56350	50	2.5 - 3	Red
N56350BL	12	2.5 - 3	Red
N56352	50	4	Blue
N56352BL	12	4	Blue
N56354	50	5 - 6	Yellow
N56354BL	10	5 - 6	Yellow



Ring Terminals - Red

- Wire size: 2.5 - 3mm

Part No.	Qty (per pack)	Tab Dia. (mm)
N56358	50	4.3
N56358BL	20	4.3
N56360	50	5
N56360BL	20	5
N56362	50	6.3
N56362BL	12	6.3



Male Blade Terminals

- Tab size: 6.3 x 0.8mm

Part No.	Qty (per pack)	Wire Size (mm)	Colour
N56320	50	2.5 - 3	Red
N56320BL	20	2.5 - 3	Red
N56322	50	4	Blue
N56322BL	20	4	Blue
N56324	50	5 - 6	Yellow
N56324BL	15	5 - 6	Yellow



Ring Terminals - Blue

- Wire size: 4mm

Part No.	Qty (per pack)	Tab Dia. (mm)
N56364	50	5
N56364BL	20	5
N56366	50	6.3
N56366BL	20	6.3
N56368	50	8.4
N56368BL	20	8.4



Female Blade Terminals

- Tab size: 6.3 x 0.8mm

Part No.	Qty (per pack)	Wire Size (mm)	Colour
N56328	50	2.5 - 3	Red
N56328BL	20	2.5 - 3	Red
N56330	50	4	Blue
N56330BL	20	4	Blue
N56332	50	5 - 6	Yellow
N56332BL	15	5 - 6	Yellow



Ring Terminals - Yellow

- Wire size: 5 - 6mm

Part No.	Qty (per pack)	Tab Dia. (mm)
N56370	50	6.3
N56370BL	12	6.3
N56372	50	8.4
N56372BL	15	8.4
N56374	50	9.5
N56374BL	12	9.5



Narva Professional Terminal and Connector Assortment



Durable plastic case designed for the tradesman, auto electrician or motor mechanic. Contains the most popular insulated terminal and connector types and one crimping tool.

- 20 separate sections with a total of 910 pieces.
- Comprises of:

56120 x 50	56174 x 50	56136 x 50	56143 x 50
56146 x 50	56160 x 15	56152 x 50	56156 x 50
56172 x 50	56134 x 50	56180 x 50	56190 x 40
56160 x 15	56150 x 50	56141 x 50	
56122 x 50	56178 x 50	56154 x 50	
56148 x 50	56504BL x 1	56188 x 40	



Each section is clearly identified for re-ordering

Includes 1x 'Tradesman' plier type crimping tool

Part No.
N56530

Electric Terminals Cable Joiners

Solderless electrical connections used to connect wires.

- Nylon butt connectors.
- Conveniently colour-coded.
- Supplied in bags of 50.



Part No.	Wire Size (mm)	Colour
JPW88081	0.5 - 1.5	Red
JPW88082	1.5 - 2.5	Blue
JPW88083	4 - 6	Yellow

Electric Terminal Cable Joiners Kit - 200 Pieces

Includes three sizes of heat shrink butt connectors supplied in a clear plastic box with dividers.

- Transparent heat-shrinkable high-density polyolefin.
- Adhesive lined and conveniently colour coded.
- Comprises of:

- Red (2.5-3mm) x 90
- Blue (4mm) x 90
- Yellow (5-6mm) x 20



Part No.
JPW12692

Narva Battery Cable Lugs



Electro tin-plated copper for high conductivity.

- Long shank for secure crimping.
- Rounded ends for easy insertion.
- Split fold for a better finish on soldered terminals.
- Sold in packs of 10.



Part No.	Suits Stud Size (mm)	Ref. Number	Internal Dia. (mm)	Cable Size (mm ²)	Suits B&S Ref (mm)
N57120	6	10-6			
N57121	8	10-8	4.6	10	8 B&S
N57122	10	10-10			
N57124	6	16-6			
N57125	8	16-8	5.5	16	6 B&S
N57126	10	16-10			
N57128	6	25-6			
N57129	8	25-8	6.9	25	3 B&S
N57130	10	25-10			
N57132	6	35-6			
N57133	8	35-8	8.3	35	2 B&S
N57134	10	35-10			
N57137	8	50-8			
N57138	10	50-10	9.5	50	0 B&S
N57139	13	50-12			
N57140	8	70-8			
N57141	10	70-10	11.2	70	00 B&S
N57142	13	70-12			

Narva Cable Lug Assortment - 165 Pieces



Contains cable lugs ranging from 10mm² – 70mm². Packed in a quality plastic case with an identification chart for easy re-ordering.

- Comprises of:

57120 x 10	57138 x 10	57132 x 10	57126 x 10
57128 x 10	57122 x 10	57140 x 5	57134 x 10
57137 x 10	57130 x 10	57125 x 10	57142 x 5
57121 x 10	57139 x 10	57133 x 10	
57129 x 10	57124 x 10	57141 x 5	



Part No.
N57110

Narva Professional Ratchet Crimping Kit



Ideal for the tradesman, auto electrician, motor mechanic or handyman. This crimping kit features interchangeable heads, allowing one tool to service all your crimping needs - from insulated and non-insulated terminals, through to cable lugs.

- The easy-to-use heavy-duty ratchet action and spring release provides a high quality crimp.
- Includes 4x interchangeable heads.



HEAD A: Suitable for blue, red and yellow insulated terminals.

HEAD B: Suitable for cable lugs sizes 2.5mm - 16mm.

HEAD C: Double crimp, suits non-insulated terminals.



HEAD 12: Single crimp, suits non-insulated terminals.



Part No.
N56513

Narva Cable Stripping Tool



Efficient design makes wire stripping quick and easy.

- Crimps insulated and non-insulated terminals.
- Strips and cuts wire from 1.13 – 6mm.



Part No.
N56511

Narva Heavy Duty Cable Cutting Tool



This quality tool is manufactured for cutting cable up to 60mm.



Part No.
N56515

Narva Flameless Heat Gun



This convenient heat gun is ideal for automotive, household and hobby applications. Features an easy-to-use trigger action with locking option.

- Lighter supplied without gas, can be refilled using butane filler gas or easily replaced with a standard cigarette lighter.
- Includes heat shield (replacements available).



N56393
Heat shield



Part No.	Description
N56392BL	Flameless Heat Gun
N56393	Replacement Heat Shield

Narva Pipe/Cable Support Clamps



Manufactured from high quality U.V. resistant EPDM rubber moulded to galvanised steel for superb clamp strength.

- Sold in packs of 10

Part No.	Inside Dia (mm)	Ref No.
N56483	19	PS4
N56484	22	PS5
N56485	27	PS6
N56486	32	PS7
N56487	35	PS8
N56488	40	PS9
N56489	45	PS10
N56490	50	PS11
N56491	55	PS12
N56492	60	PS13



Narva Nylon Cable Clips (P-Clips)



Manufactured from UV-resistant nylon.

- Ideal for all applications including marine.
- Sold in blister packs of 5 or bulk pack of 100.



Part No.		Internal Dia (mm)
Pack of 5	Pack of 100	
N56581BL	N56581	4.3
N56582BL	N56582	6.4
N56583BL	N56583	7.9
N56584BL	N56584	9.5
N56585BL	N56585	12.7
-	N56586	15.9
-	N56587	19.0

Nylon Cable Ties - Black

Self-locking mechanism ensures that the ties stay in place.

- Sturdy construction.
- Sold in packs of 100.



Part No.	Dimensions L x W (mm)
JPW2101	100 x 2.5
JPW2102	150 x 3.6
JPW2103	200 x 4.6
JPW2104	300 x 4.8

Narva Piral Wraps



Manufactured from black polyethylene.

- Operating temperature of -76°C to 96°C.
- Sold in 10m lengths.

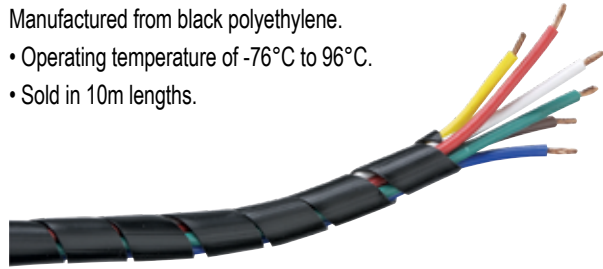

Part No.	Internal Dia (mm)	Wrapping Range Dia. (mm)
N56700	6	6 - 18
N56702	12	12 - 35

Narva Insulation Tapes



Flame retardant with gloss finish.

- 19mm wide
- 20m length.



Part No.	Colour
N56830BK	Black
N56830RD	Red

Narva Harness Tape



PVC harness tape with matte finish.

- 25mm wide
- 20m length.



Part No.	Colour
N56840BK	Black

Narva Corrugated Split Sleeve Tubing



Black UV-resistant, fire-retardant polypropylene for general applications.

- No tools required, just snap together.
- Operating temperature -20°C to 90°C



Part No.	Length (m)	Tube Size (mm)	Internal Dia (mm)
N56707	10	7	7.0
N56710	10	10	9.7
N56713	10	13	12.6
N56716	10	16	16.3
N56720	10	20	21.1
N56723	5	23	23.0
N56729	3	29	29.0
N56736	5	36	36.0
N56748	5	48	48.0



Narva Heatshrink Tubing

Made from flame-retardant/self-extinguishing poly-olefin. The adhesive used also creates a waterproof seal making it suitable for most auto/marine applications.

- Sold as a single 1.2m length



Part No.		Pre-Shrunk Dia (mm)	Shrunk Dia (mm)
Black	Red		
N56612	N56632	3.2	1.6
N56614	N56634	4.8	2.4
N56616	N56636	6.4	3.2
N56618	N56638	9.5	4.8
N56620	N56640	12.7	6.4
N56622	N56642	19	9.5
N56624	N56644	25.4	12.7

Narva Heatshrink Tubing Assortment Packs of 12

Heatshrink tubing, all 150mm long.



Part No.	Dia (mm)
N56600	3.2 - 6.4
N56602	9.5 - 19

Narva Heatshrink Tubing Assortment Box - 216 Pieces

Heatshrink tubing selection - various sizes.

- Comprises of:

45mm Lengths

Black: 2.5mm x 50	Red: 2.5mm x 20
3.5mm x 30	3.5mm x 15
4.5mm x 20	4.5mm x 10
6mm x 10	6mm x 5
10mm x 10	10mm x 10
13mm x 10	13mm x 10

75mm Lengths

Black: 20mm x 8
Red: 20mm x 8



Part No.
N56604

Narva Dual Wall Heatshrink Tubing Assortment Pack of 6

Lined with an inner adhesive, providing excellent weather resistance and adhesion to cable.

- Comprises of:

300mm Lengths

Black: 3mm x 1	Red: 3mm x 1
4.8mm x 1	4.8mm x 1
6mm x 1	6mm x 1



Part No.
N56650

Narva Dual Wall Heatshrink Tubing Assortment Box - 105 Pieces

Dual wall heatshrink tubing selection - various sizes.

- Comprises of:

45mm Lengths

Black: 3.2mm x 28
4.8mm x 16
6.4mm x 7
9.5mm x 6
Red: 3.2mm x 12
4.8mm x 8
6.4mm x 4
9.5mm x 3

75mm Lengths

Black: 12.7mm x 5	Red: 12.7mm x 3
19.1mm x 3	19.1mm x 2
25.4mm x 4	25.4mm x 4



Part No.
N56654

Multi Core Trailer Cables

For caravan and trailer wiring applications.

- 5 Core Colours: White, Yellow, Brown, Red, Green.
- 7 Core Colours: White, Yellow, Brown, Red, Green, Black, Blue.
- Voltage Rating: 60V DC or 25V AC
- Meets AS/NZS 3808 standards.
- Black sheath.

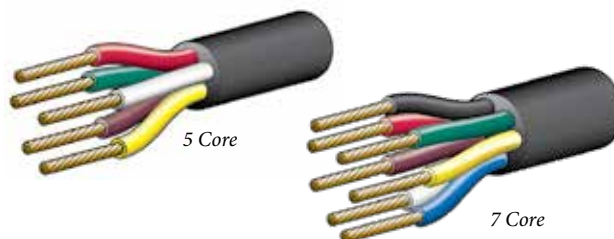

Part No.		Dia (mm)	Cores	Stand No/Dia	Conductor X Section (mm ²)	Amps Rating
30m Coil	100m Coil					
JPW88182	-	3	5	14/0.32	1.13	11
JPW88194	-	3	7	14/0.32	1.13	10
JPW88195	JPW88197	4	7	23/0.32	1.84	14

Battery and Starter Cables

For battery and starter cable applications. Meets AS/NZS 3808 standards.

- Voltage Rating: 60V DC or 25V AC.
- Coil length: 30m.



Part No.		Nearest B&S Size	Normal Area (mm ²)	Stand No/Dia	Amps Rating
Black	Red				
JPW88100	JPW88102	8	7.71	96/0.32	74
JPW88104	JPW88106	6	13.5	168/0.32	103
JPW88108	JPW88110	4	20.26	252/0.32	135
JPW88112	JPW88114	3	26.45	329/0.32	168
JPW88116	JPW88118	2	32.07	399/0.32	188
JPW88120	JPW88122	0	49	608/0.32	246
JPW88124	JPW88126	00	64.15	798/0.32	292

Tinned Twin Core Cables

For marine trailer wiring, general purpose wiring, lights, instrumentation.

- Red and black with white sheath.
- Tin coated copper suitable for marine applications.
- Voltage Rating: 120V DC.
- Meets AS/NZS 3808 standards.

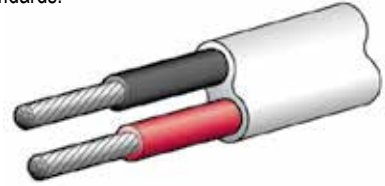

Part No.		Cable Dia (mm)	Normal Area (mm ²)	Stand No/ Dia (mm)	Amps Rating
50m Coil	100m Coil				
JPW88168	JPW88169	3	1.13	14/0.32	16
JPW88170	JPW88171	4	1.84	23/0.32	22
JPW88172	JPW88173	6	4.5	57/0.32	38

Tinned Single Core Cables - Extra Low Voltage

For general pleasure craft marine wiring.

- Tin coated copper suitable for the marine applications.
- Meets AS/NZS3808 standards.
- Voltage Rating: 120V DC.
- Coil length: 50m.



Part No.		Nearest B&S Size	Normal Area (mm ²)	Stand No/Dia	Amps Rating
Black	Red				
JPW88140	JPW88142	4	1.84	23/0.32	28
JPW88144	JPW88146	6	4.59	57/0.32	48

Twin Sheath 2 Core Cables

For trailer wiring, general purpose wiring, lights, instrumentation.

- Red and black with black sheath.
- Meets AS/NZS 3808 standards.
- Voltage Rating: 120V DC.



Part No.		Cable Dia (mm)	Normal Area (mm ²)	Stand No/ Dia (mm)	Amps Rating
30m Coil	100m Coil				
JPW88133	JPW88134	3	1.13	14/0.32	16
JPW88135	JPW88136	4	1.84	23/0.32	22
JPW88137	JPW88138	6	4.59	57/0.32	38

Twin Core Figure 8 Cables

For speaker connection hook-up.

- Colours: Red with a black strip
- Voltage Rating: 60V DC or 25V AC.
- Meets AS/NZS 3808 standards.



Part No.		Nearest B&S Size	Normal Area (mm ²)	Stand No/ Dia (mm)	Amps Rating
30m Coil	100m Coil				
JPW88158	JPW88156	3	1.13	14/0.32	10
JPW88162	JPW88160	4	1.84	23/0.32	15

Tinned 3 Core Cables

Marine trailer wiring, general purpose marine wiring applications.

- 3 core colours: (White, Yellow, Brown) White Sheath.
- Tin coated copper suitable for marine applications.
- Voltage Rating: 120V DC.
- Meets AS/NZS 3808 standards.
- 100m coils available on request.



Part No.	Coil Length (m)	Cable Dia (mm)	No. Of Cores	Stand No/ Dia	Conductor X Section (mm ²)	Amps Rating
JPW88186	50	4	3	23/0.32	1.84	19
JPW88187	100					

Wema Tank Level Senders

Magnetic read switch senders suitable for use wide range of mediums including, diesel, petrol, oil, potable and grey water.

- AISI 316 stainless steel, ignition protected with ISO8846 certification.
- **S3 Threaded:** 1 1/4" BSP thread mounted type with O-ring seals.
- **S5 Flanged:** SAE 5 hole flange mount includes nitrile gasket.
- US 240-30 Ohms or Euro 0-190 Ohms standard.
- Operating voltage: 12/24V
- Longer senders available on request.



S5: 5-Hole SAE Flange

Resistance 240-30 Ohms		Resistance 0-190 Ohms		Length (mm)
Part No.	Model	Part No.	Model	
JPW2542-1	S5-A100	-	-	100
JPW2542-2	S5-A125	-	-	125
JPW2542	S5-A150	JPW2619	S5-E150	150
JPW2543	S5-A175	JPW2620	S5-E175	175
JPW2544	S5-A200	JPW2621	S5-E200	200
JPW2545	S5-A225	JPW2622	S5-E225	225
JPW2546	S5-A250	JPW2623	S5-E250	250
JPW2547	S5-A275	JPW2624	S5-E275	275
JPW2548	S5-A300	JPW2625	S5-E300	300
JPW2549	S5-A350	JPW2626	S5-E350	350
JPW2550	S5-A400	JPW2627	S5-E400	400
JPW2551	S5-A450	JPW2633	S5-E450	450
JPW2552	S5-A500	JPW2634	S5-E500	500
JPW2553	S5-A550	JPW2632	S5-E550	550
JPW2560	S5-A600	JPW2636	S5-E600	600
JPW2567	S5-A650	-	-	650
JPW2568	S5-A700	JPW2635	S5-E700	700
JPW2566	S5-A750	-	-	750
JPW2564	S5-A800	-	-	800
JPW2565	S5-A1000	JPW2631	S5-E1000	1000

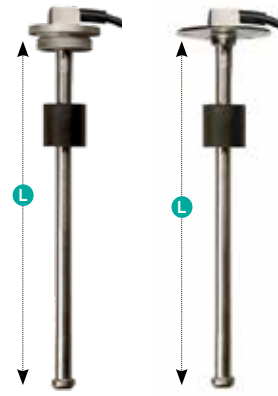

Length is measured from the underside of the flange to the base of the shaft.



JPW2474
Replacement gasket to suit S5 senders

S3: 1 1/4" BSP thread

S5: 5-hole SAE flange



S3: 1 1/4" BSP Thread

Resistance 240-30 Ohms		Resistance 0-190 Ohms		Length (mm)
Part No.	Model	Part No.	Model	
JPW2606-1	S3-A100	-	-	100
JPW2606-2	S3-A125	-	-	125
JPW2606	S3-A150	JPW2637	S3-E150	150
JPW2607	S3-A175	JPW2638	S3-E175	175
JPW2608	S3-A200	JPW2639	S3-E200	200
JPW2609	S3-A225	JPW2640	S3-E225	225
JPW2610	S3-A250	JPW2641	S3-E250	250
JPW2611	S3-A275	JPW2642	S3-E275	275
JPW2612	S3-A300	JPW2643	S3-E300	300
JPW2613	S3-A350	JPW2644	S3-E350	350
JPW2614	S3-A400	JPW2645	S3-E400	400
JPW2615	S3-A450	JPW2646	S3-E450	450
JPW2616	S3-A500	JPW2647	S3-E500	500
-	-	JPW2676	S3-E550	550
-	-	JPW2673	S3-E700	700
JPW2618	S3-A800	JPW2674	S3-E800	800
-	-	JPW2675	S3-E850	850
JPW2617	S3-A1000	JPW2649	S3-E1000	1000

Wema Fuel Level Gauges



12V - dropping resistor included for 24V applications.

- Black dial with black plastic bezel or stainless steel bezel.
- Indication range: Empty to Full.
- 52mm cut-out.



JPW2580 / JPW2582

JPW2582-BS

Part No.	Resistance (Ohm)	Bezel	Dia (mm)
JPW2582	0 - 190	Black	65
JPW2582-BS	0 - 190	Stainless Steel	56
JPW2580	240 - 30	Black	65

Wema Water Level Gauges



12V - dropping resistor included for 24V applications.

- Black dial with black plastic bezel or stainless steel bezel.
- Indication range: Empty to Full.
- 52mm cut-out.



JPW2579 / JPW2583

JPW2583-BS

Part No.	Resistance (Ohm)	Bezel	Dia (mm)
JPW2583	0 - 190	Black	65
JPW2583-BS	0 - 190	Stainless Steel	56
JPW2579	240 - 30	Black	65

KUS Tank Level Senders



Magnetic read switch sender suitable for use in both fuel and water applications.

- Standard SAE 5 hole pattern.
- 2mm thick FPM gasket.
- 240-33 Ohms.



Length is measured from the underside of the flange to the base of the shaft.

Part No.	Length (mm)
JPW2476	150
JPW2477	175
JPW2478	200
JPW2479	225
JPW2480	250
JPW2481	275
JPW2482	300
JPW2484	350
JPW2486	400
JPW2487	450
JPW2488	500

Wema Tank Level Sender Adaptors



- **JPW2466** Topside/Underside Flange Kit: Stainless steel flange with 1 1/4" BSP thread, complete with gasket, inner ring and screws.
- **JPW2467** Underside Flange Adaptor: Stainless steel underside flange ring with stainless steel screws. Provides a SAE 5 hole pattern for S5 senders or FL-2 (JPW2468) topside flange adaptor.
- **JPW2468** Topside Flange Adaptor: Nylon topside flange and nitrile gasket creates 1 1/4" BSP thread. Also features the standard SAE 5 hole pattern.



JPW2468

Part No.	Model
JPW2466	HFL
JPW2467	FLS-U
JPW2468	FL-2



JPW2466



JPW2467

KUS Fuel Level Gauge



Black dial face plate with black plastic bezel with reinforced anti-fog lens

- Indication range: Empty to Full.
- 52mm cut-out / 60mm diameter.
- Voltage: 12/24V



Part No.	Resistance (Ohm)
JPW2525	240 - 33

Wema Waste Tank Level Senders - Threaded



Magnetic reed switch sensor made from 316-grade stainless steel. Features a removable screen to reduce the ingress of solids.

- Grey and black water - not suitable for fuel.
- Voltage: 12/24 VDC.
- Resistance: 240 - 30 Ohm.
- Mounting: Threaded 1 1/4" BSP.



Part No.	Model	Length (mm)
JPW2462	S3H-1	100
JPW2463	S3H-2	205
JPW2464	S3H-3	305
JPW2465	S3H-4	410
JPW2469	S3H-5	510

KUS Water Level Gauge



Black dial face plate with black plastic bezel with reinforced anti-fog lens.

- Indication range: Empty to Full.
- 52mm cut-out / 60mm diameter.
- Voltage: 12/24V



Part No.	Resistance (Ohm)
JPW2526	240 - 33

Wema Waste Level Gauge



12V - dropping resistor included for 24V applications.

- Black dial with black plastic bezel.
- 52mm cut-out / 65mm diameter.
- Range: Low - Full.

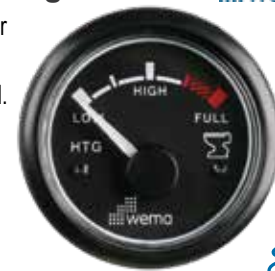

Part No.	Resistance (Ohm)
JPW2584	240 - 30

Wema Voltmeter Gauge



- Black dial with black plastic bezel.
- 52mm cut-out / 65mm diameter.
- Range: 12VDC 8-16V DC.
24VDC 18-32V DC



Part No.	Volts
JPW2585	12v
JPW2586	24v



Wema Digital Voltmeter

- Black dial with black plastic bezel.
- 52mm cut-out / 65mm diameter.
- Range 8 - 32VDC.



Part No.	Range
JPW2587	8 - 32VDC



Wema Oil Temperature Gauge

- Black dial.
- Black plastic bezel.
- 52mm cut-out / 65mm diameter.
- Voltage: 12VDC (24VDC with resistors)



Part No.	Resistance (Ohm)	Range
JPW2591	260 - 23	40 - 120°C



Digital LED Volt Meter

Features 3 digital LED display and quick terminals.

- Size: 61 x 49mm
- Cut out: ø 29mm



Part No.	Range
JPW12961	2.5 - 30VDC

Wema Digital Ammeter

Supplied with a 150amp shunt to suit.

- Black dial.
- Black plastic bezel.
- 52mm cut-out / 65mm diameter.
- Range -150 to +150 Amps.
- Multivolt: 12/24VDC.



Part No.	Range
JPW2588	-150 to +150 Amps



Wema Coolant Temperature Gauge

- Black dial.
- Black plastic bezel.
- 52mm cut-out / 65mm diameter.
- Voltage: 12VDC (24VDC with resistors).



Part No.	Resistance (Ohm)	Range
JPW2592	260 - 23	40 - 120°C



Wema 60kn GPS Speedo Gauge

GPS Speedo / Analogue indication.

- Black dial.
- Black plastic bezel.
- 85mm cut-out / 105mm diameter.
- Proprietary GPS Antenna.
- Voltage: 12VDC or 24VDC.



Part No.	Range
JPW2594	0 - 60 Knots



Wema Digital Hourmeter Gauge

- Suitable for 12/24VDC systems
- Black dial.
- Black plastic bezel.
- 52mm cut-out / 65mm diameter.



Part No.	Range
JPW2589	0 - 99999.9 hrs



Wema Rudder Angle Gauge

- Suitable for 12/24VDC systems
- Black dial.
- Black plastic bezel.
- 52mm cut-out / 65mm diameter.



Part No.	Resistance (Ohm)
JPW2593	0 - 190



Wema Oil Pressure Gauge

- Black dial.
- Black plastic bezel.
- 52mm cut-out / 65mm diameter.
- Voltage: 12VDC (24VDC with resistors).



Part No.	Resistance (Ohm)	Range
JPW2590	10 - 185	0 - 5 bar



Wema Rudder Angle Indication Sender

Dual station rudder angle sender, featuring a standard resistance value compatible with other popular European brands.

- Connects two gauges at the same time.
- Angle Range: 40° - 0 - 40°



Part No.	Resistance (Ohm)
JPW2535	0 - 190

Marine Bilge Blowers

Centrifugal blower with the best ratio between volume air flow and compact size on the market.

- Very strong dynamic flange mount or flex mount.
- Made from strong nylon material with stainless steel shaft and screws.
- Continuous duty with low current draw.
- Max temperature rating: 60-65°C.
- Complying with ISO 8849, EN 55014, ISO 10133.



Part No.	Mount	Capacity (CMH)	Volts	Amps	Suits Hose Size	Outlet (mm)	Dimensions (mm)
JPW15899	Flange	280	12V	3.8A	75mm (3")	72	200 x 165 x 195
JPW15900	Flange	280	24V	2A	75mm (3")	72	200 x 165 x 195
JPW15901	Flex	550	12V	12A	100mm (4")	103	290 x 257 x 150

In-Line Bilge Blowers

Modern inline blowers utilizing advanced five fan blade design technologies for maximum flow and performance, suitable for bulkhead mounting.

- Incorporates an engineered nylon housing with flexible installation.
- Compact simple design, intermittent or continuous duty.
- Port connection: 178mm.
- Long motor lifetime from powerful airflow cooling.
- Quiet operation with low power consumption.
- Max temperature rating: 60-65°C.
- Meets ISO 8846, EN 55014 standards.



JPW15904 / JPW15906

JPW15902 / JPW15903 / JPW15905

Part No.	Type	Capacity (CMH)	Volts	Amps	Dimensions L x Dia (mm)
JPW15902	Intermittent	750	12V	5A	250 x 220
JPW15903	Intermittent	750	24V	2.5A	250 x 220
JPW15904	Intermittent	750	12V	5A	165 x 220
JPW15905	Continuous	1000	24V	3.5A	250 x 220
JPW15906	Continuous	1000	24V	3.5A	165 x 220

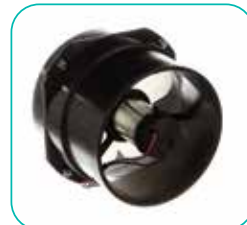

In-Line Bilge Blowers

Easy to install, in-line 12V bilge blowers with 3" or 4" hose intake and sealed motor shaft and wires for moisture protection.

- High volume ventilation with low amp draw.
- Meets ABYC U.S. Coast Guard, CE Standards.

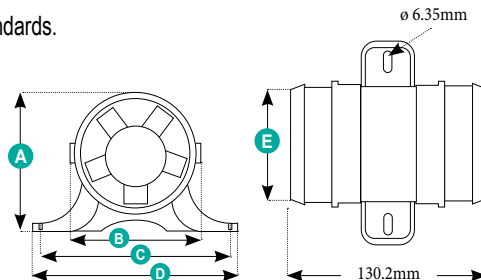

Part No.	Amps	Open Flow Rate (CFM)	Suits Hose Size	Dimensions (mm)				
				A	B	C	D	E
JPW12980	1.5A	120	75mm (3")	90	78	121	90	76
JPW12981	2.5A	130	100mm (4")	117	118	146	157	102

TotalCool 3000 Portable Evaporative Cooling System

TOTALCOOL

High quality evaporative cooling, using the latest technology and ergonomic designs, working on 12V, 24V and AC mains power.

- Built in battery protection system with automatic cut off.
- Up to 45% colder air over 7 meters.
- Lightweight, compact and portable.
- 4 speed settings.
- Runs on normal tap water.
- Low current draw 0.3 - 1.8A.
- Includes power leads, cooling filter pads, window sticker & user guide.
- Use with Totalfresh Essential Oils pack: **JPW88052**.



NEW 2023



Replacement Cooling Pads (2 pack) **JPW88053**

Part No.	Dimensions L x W x H (mm)
JPW88048	260 x 240 x 210

TotalFresh Essentials Oils 5 Pack

TOTALCOOL

For use with the TotalCool 3000 Evaporative Cooling system above.

NEW 2023



Part No.	Oils Included	Capacity
JPW88052	Tea Tree, Peppermint, Citronella, Lemongrass & Eucalyptus	10mL

Totalcool Portable Fridge Freezers

TOTALCOOL

Manufactured from the highest quality components, these dual zone fridge/freezers are lightweight, robust and beautifully designed.

- Ultra energy efficient with low current draw.
- High quality, strong and durable.
- Smart LED display and control system.
- Stays cold up to 8 hours once unplugged.
- Input Power: 12V / 24V / AC Adapter.
- Power Consumption: 30-40W / 2.5-3.3A.
- Temperature Range: -20°C to +20°C
- Includes removable basket.



NEW 2023



Part No.	Litres (L)	Weight (kg)	Dimensions L x W x H (mm)
JPW88032	35	12	690 x 345 x 382
JPW88034	45	13	690 x 345 x 462
JPW88036	55	14	690 x 345 x 524

Stainless Steel Compact Electric Horn

A single compact marine horn with a stainless steel cover and mounting base. Includes a non-corrosive black ABS plastic horn base and rubber mounting gasket.

- Current Draw: 3A @ 12V
- Sound Rating: 100 db



Part No.	Dimensions L x W x H (mm)
JPW5894	90 x 80 x 50

Marine Horn with Support Bracket Mount



Fully watertight and corrosion-resistant marine electromagnetic horn, supplied with stainless steel support fixing plate.

- Easily positioned on deck and suitable for roll bar installation.
- Casing made from strong ABS material.
- Tested at 50,000 cycles (1" on / 4" off).
- Dimensions: 100 x 155 x 60mm

NEW 2023



Part No.	Colour	Voltage	Amps
JPW15911	White	12V	4.5A
JPW15912	Black	12V	4.5A

Stainless Steel Electric Horns

Marine quality, trumpet horn with 100% stainless steel exterior. The single horn produces a high tone and the double horn produces dual high and low tones.

- Supplied complete with integral stainless steel mounting bracket on rear and shaft of horn.
- Sound Rating: 115db +/-5
- Blister packed.



Part No.	Current Draw	Dimensions L x W x H (mm)
JPW5896	2.5A @ 12V	420 x 100 x 120
JPW5899	4.5A @ 12V	455 x 125 x 189

HOW TO ORDER

Select products from the catalogue or through our website using the product categories or search function. Make note of the part numbers to facilitate ordering.

ONLINE



Login to our website
with your customer username & password.

www.jpwmarine.com.au

If you know our product codes, use the
'Quick Order' form for a speedy checkout.

PHONE



Call us during standard
Western Australian business hours on

(08) 6253 3000

to place order by phone.

EMAIL



Email your order to

orders@jpwmarine.com.au



JPW MARINE

WHOLESALE MARINE SPECIALISTS