

PUMPS & PLUMBING 16

WATER HEATERS

B3 Water Heaters 16.02 - 16.03

TOILETS & ACCESSORIES

Electric Toilets 16.04
Manual Toilets 16.05
Electric Conversion Kits 16.05
Diaphragm Flush Pump 16.05
Toilet Seat 16.05
Macerator Pumps 16.06
Portable Camping or Fishing Toilets 16.06

PUMPS & ACCESSORIES

Bilge Pumps 16.06
Automatic Bilge Float Switches 16.07
Macerator Pumps 16.06
Freshwater Pumps 16.07 - 16.08
Deckwash Pumps 16.08 - 16.09
Pump Accessories 16.09
Accumulator Tank 16.10
Drill Pump Kit 16.06
Filters 16.10

HOSES

Expandable Hoses 16.10
Spray Guns 16.11
Multi-Purpose Clear Hoses 16.11
Bilge Pump Hoses 16.11 - 16.12
Sanitation Hoses 16.12
Outboard Fuel Hoses 16.12
Exhaust Hoses 16.12
Fuel Line Hoses 16.12
Hose Clamps 16.13

FITTINGS & VALVES

Skin Fittings 16.14 - 16.15
Non-Return Valves 16.15
Scupper Valve 16.15
Thru-Transom Scupper 16.15
Hose Connectors 16.15
Ball Valves 16.15
Vented Loops 16.16
Y Valves 16.16
Stainless Steel Sinks 16.16
Sink Waste and Plugs 16.16





Quick Nautic Boiler B3 Water Heaters

All of our water heaters have the following advantages and high-quality characteristics:

- High quality materials.
- Heat exchanger with wide exchange surface.
- Produces hot water from the electric element, that is fitted with an adjustable safety bi-thermostat.
- Relief / non-return valve that allows discharging of the water heater in case of disuse.
- Australian compliant pressure/temperature relief valve and thermostatic mixing valve.



Thermostatic Mixing Valve Kit

Features:

- The heat exchanger used is AISI 316 stainless steel with a capacity that is notably higher than that achieved from other manufacturers.
- The tank is made of 1.5 mm gauge AISI 316 stainless steel, welded with Argon shielding gas and is highly resistant to corrosive agents.
- The heating element is made of Incoloy®, a nickel-based superalloy that has excellent corrosion-resistance and withstands high temperatures.
- The thermal insulation is high-density polyurethane foam injected between the cover and tank to give excellent heat-retention properties.

Water heating time (example) for Quick B3 Hot Water Heater 40L 1300W:
 15 mins to take the chill off / 30 mins for warm water / 45 mins for hot water.
 These times will vary depending on size of the tank and wattage of heating element.

SPECIFICATIONS

- **Tank material:** Stainless steel
- **Thermal insulator:** Polyurethane foam
- **External cladding material:** Composite
- **Tank Pressure (running test):** 800kPa**
- **Maximum working pressure:** 600kPa**
- **Electric element voltage rating:** 220 Vac ± 10%
- **Electric element power:** 500W or 1300W
- **Outputs diameter:** 1/2"

**1 Bar = 100 kPa

Optional Accessory:

- **QFVSLCSANT000A00:** Anti-flare protection: an anodised aluminium case for the heating element, to protect the water heater in potentially explosive environments (ISO 8846).



Part No.	Capacity (L)	Heating Element (W)	Dimensions (mm)			Weight (kg)
			A	B	C	
QFLB31513S000A01	15	1300	405	316	300	7.0
QFLB31505S000A03	15	500	405	316	300	7.0
QFLB32013S000A03	20	1300	500	316	300	8.1
QFLB32005S000A05	20	500	500	316	300	8.1
QFLB32513S000A09	25	1300	605	316	300	8.5
QFLB32505S000A09	25	500	605	316	300	8.5
QFLB33013S000A01	30	1300	495	384	360	10.5
QFLB34013S000A01	40	1300	620	384	360	11.7
QFLB36013S000A01	60	1300	721	406	400	14.6
QFLB38013S000A01	80	1300	921	406	400	17.8

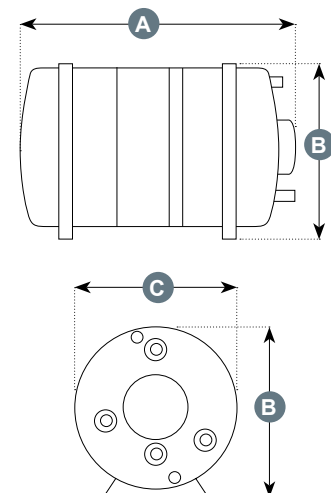



Quick Nautic Boiler B3 Water Heaters - Exploded Diagram

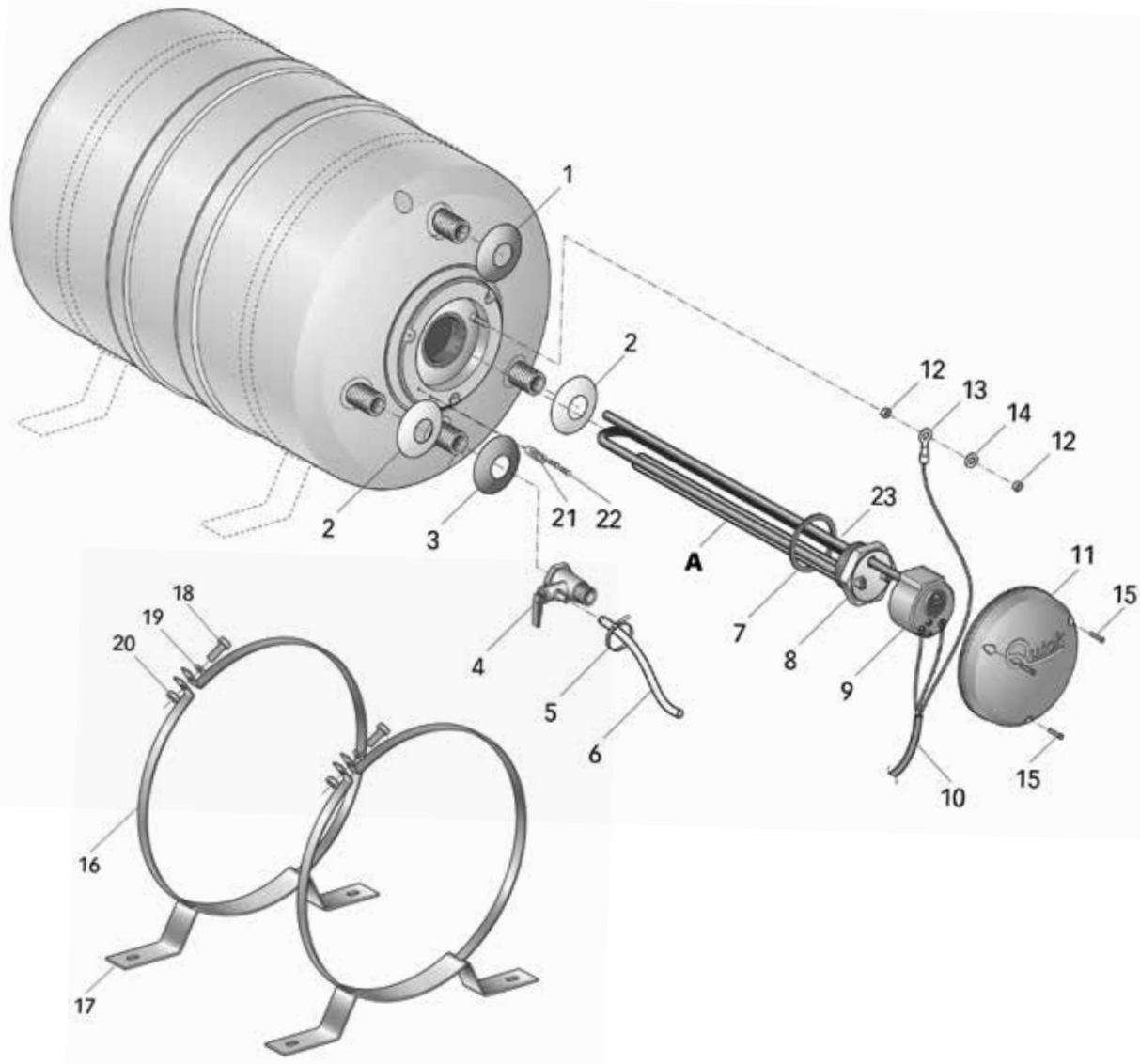

Item No.	Part No.	Description	Item No.	Part No.	Description
1	PECRBLRS0000	Red plastic washer	14	MBR04X000000	Washer
2	PECRBLBNC000	White plastic washer	15	MBV02919AXCC	Screw 2,9 x 19
3	PECRBLBL0000	Blue plastic washer	16A	MBFPNXB3300	Tank mounting B3 300
4	QFVSLVS127B00A00	Relief/non-return valve	16B	MBFPNXB3360	Tank mounting B3 360
5	PBF25100W000	Hose clamp	16C	MBFPNXB3400	Tank mounting B3 400
6	PVTBGM10NT00	Discharge pipe	17A	MMSTXB3000000	Metal bracket B3 300
7A	PGGRES0000000	Element gasket	17B	MMSTBL400DR1	Metal bracket B3 400
7B	PGRM435000000	Element gasket	18	MBV0830MXE00	Screw M8 stainless steel
8A	QFVSLRSB05220A00	Spare Element 500W 220V	19	MBR08X0000000	Washer Ø 8 stainless steel
8B	QFVSLRSB0822SA00	Spare Element 800W 220V	20	MBD08MXEN000	Nut M8 stainless steel
8C	QFVSLRSB12110A00	Spare Element 1200W 110V	21	PPBLB3000000	Cable clamp
8D	QFVSLRSB12220A00	Spare Element 1200W 220V	22	MBV02916AXCC	Screw 2,9 x 16
9	QFVSLTB152700A00	Bi-Thermostat	-	QFVSLANMG1820A00	Boiler Magnesium Anode 200mm
10	ECC30150G000	Power supply cable	-	QFVSLCSANT000A00	Anti-Flare Protection
11	PECRB220B300	B3 resistor cover 220V	-	QFLKMT0000000A00	Thermostat Mixing Valve Kit
12	MBD04MXEN000	Nut M4 stainless steel			
13	EJCY04000000	Ground cable terminal			



Electric Toilets Standard Flush

Standard flush toilet with pure white vitreous china bowl and soft close seat lid. Low water consumption with a powerful self-priming pump for above or below waterline installation.

- Rotating 90° pump.
- Expulsion up to 3.5m in height.
- Self priming up to 1.5m vertically.
- Impact resistant material base.
- Port connections: Inlet: 19mm (3/4") Outlet: 25mm & 38mm (1" & 1-1/2").
- Voltage: 12V | Amps: 17A.
- Evolution conversion kit upgrade available (JPW15871 / JPW15872).



JPW15855



JPW15856



Includes one button switch panel

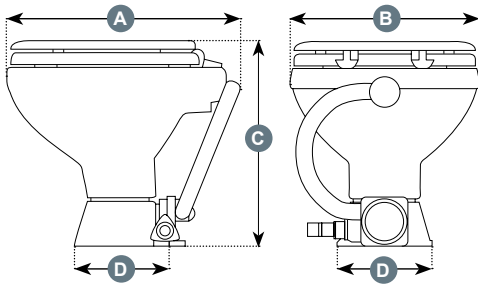

Part No.	Bowl Type	Dimensions (mm)			
		A	B	C	D
JPW15855	Compact	425	345	373	172
JPW15856	Space Saver	425	345	345	172

Electric Toilets Silent Flush

Silent flush toilet with pure white vitreous china bowl and soft close seat lid. Use existing boat fresh water pump or additional diaphragm pump (JPW15877 / JPW15878) for salt water flush.

- Low water consumption.
- Expulsion up to 7m in height.
- Impact resistant material base.
- Port connections: Inlet: 19mm (3/4") Outlet: 25mm & 38mm (1" & 1-1/2").
- Standard or Evolution conversion kit upgrades available (see page opposite).



Comfort Bowl



Compact Bowl

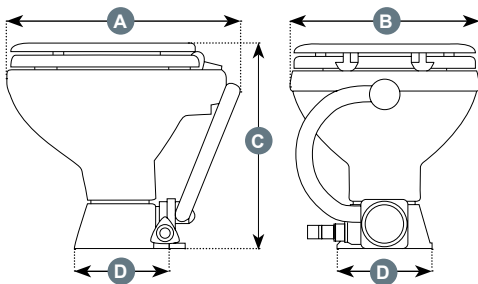

Part No.	Bowl Type	Volts	Amps	Dimensions (mm)			
				A	B	C	D
JPW15857	Compact	12V	17A	425	335	390	172
JPW15858	Compact	24V	8A	425	335	390	172
JPW15859	Comfort	12V	17A	460	365	385	172
JPW15860	Comfort	24V	8A	460	365	385	172



Includes intelligent control system panel

Manual Toilets

Features a manual angled pump with long stroke for more comfortable operation. Made of white vitreous porcelain with corrosion resistant parts, it is silent, robust and easy to clean.

- Reversible pump mounting for choice of right or left-handed installation.
- Innovative spray nozzle with high pressure water jet
- Low water consumption.
- Dual lip valves prevents waste back into the bowl.
- Port connections: Inlet: 19mm (3/4") Outlet: 38mm (1" & 1-1/2").

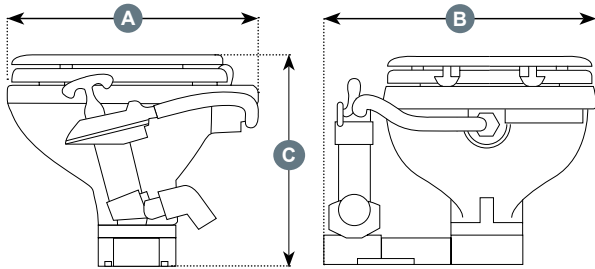

Part No.	Bowl Type	Dimensions (mm)		
		A	B	C
JPW15861	Compact	425	450	325
JPW15862	Space Saver	425	450	285



Electric Toilet Standard Conversion Kits

Converts the bowl of most toilets to the ease and convenience of electric operation. Suits most toilets with 4 bolt fixing and bolt centres on a 95 mm (3 3/4") diameter circle, such as Matromarine, Jabsco, TMC, Raritan, RM69, Johnson Pump, Thetford & Lalizas.

- Contains stainless steel bolts and washers, hose, gaskets and control panel.
- Space saving and rotating 90 degrees.
- Pump easily accessible for servicing.
- Corrosion resistant materials.

Part No.	Voltage
JPW15873	12V
JPW15874	24V



Diaphragm Flush Pump for Silent Electric Toilets

Silent 4 diaphragm pump, brings in ocean water to rinse toilet bowl.

- For Ocean Technologies Silent Toilets.
- Includes strainer.
- Delivery: 12 litres.

Part No.	Voltage
JPW15877	12V
JPW15878	24V



Electric Toilet Evolution Conversion Kits

Same as above but with a new high-performance discharge pump and extremely silent operation.

- Includes a 360° rotatable discharge port connection.

Part No.	Voltage
JPW15871	12V
JPW15872	24V



Toilet Seat with Soft Close Lid

Soft close seat suitable manual or electric toilets.

- Interchangeable with Ocean Technologies, Jabsco, SPX, TMC and RM69 toilets.



Part No.	Suits Ocean Tech Bowl Type	Dimensions (mm)			
		A	B	C	D
JPW15855	Space Saver / Compact	215	225	330	335
JPW15856	Comfort	220	270	385	345

Portable Toilets

This lightweight portable toilet is convenient, clean and water efficient. All seals have passed through a strict air pressure test.

- Reliable and durable.
- Injection piston flush.
- Fresh water tank on top.
- Removable waste holding tank on bottom.



JPW2702

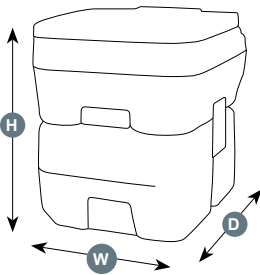

JPW2701

Part No.	Size (L)	Height (mm)	Width (mm)	Depth (mm)
JPW2701	10	300	350	410
JPW2702	20	420	350	410

Shurflo Bilge Pumps



Manufactured to withstand tough marine conditions, featuring 900mm (3ft) tinned power leads to protect the wires from corrosion.

- Continuous duty and anti-airlock.
- 12V permanent magnet motor.
- Submersible and water cooled motor.
- High strength nylon impeller.
- 3/4" barb port outlet.
- ABS housing with quick-disconnect base plate.
- Do not run dry.
- Approvals: Ignition protected (ISO 8849), CE, IMCI Certified.

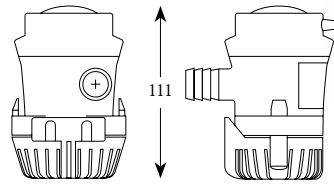

(Dimensions in mm)

Part No.	Flow Rate	Voltage	Amps
JPW3521	380 GPH (24 LPM)	12V	1.7A
JPW3522	500 GPH (32 LPM)	12V	1.8A
JPW3523	700 GPH (44 LPM)	12V	3.2A

Macerator Pump 43LPM



Bronze macerator and rubber impeller discharge pump. Intermittent duty (do not run dry for longer than 30 secs) and self priming up to 0.6m vertical lift.

- Connection input: 38mm hose barb, output: 25mm
- 43 LPM output at 3m total head.



Part No.	Voltage	Amps
JPW15889	12V	12A
JPW15890	24V	6A

Shurflo Macerator Pumps



Designed to empty marine and RV waste holding tanks in minutes, these pumps feature a unique stainless steel dual-cut blade that will ground up small debris thoroughly.

- Seamless shell design with a flexible impeller.
- High flow rate with run-dry capability.
- Sealed manual turn key.
- Themally protected.
- Self-priming.
- Inlet Port: 1-1/2" Barb and 1-1/2" NPT / Outlet Port: 1" Barb.
- Approvals: Ignition protected (ISO 8849), CE.



Part No.	Flow Rate	Voltage	Amps
JPW3536	13 GPH (49 LPM)	12V	17A
JPW3537	13 GPH (49 LPM)	24V	9A

Shurflo Bilge Pumps - High Flow



Heavy duty and built to last, these high flow bilge pumps feature 1.8m (6ft) tinned power leads to protect the wires from corrosion.

- Continuous duty and anti-airlock.
- 12V or 24V permanent magnet motor.
- Submersible and water cooled motor.
- High strength nylon housing and impeller.
- 1-1/8" barb port outlet.
- Quick-disconnect base plate.
- Do not run dry.
- Approvals: Ignition protected (ISO 8849), CE, IMCI Certified.

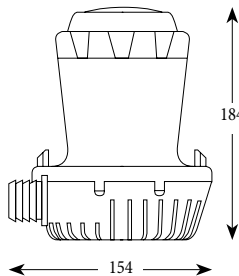

(Dimensions in mm)

Part No.	Flow Rate	Voltage	Amps
JPW3524	1500 GPH (95 LPM)	12V	8A
JPW3525	1500 GPH (95 LPM)	24V	4A
JPW3526	2000 GPH (126 LPM)	12V	10A
JPW3527	2000 GPH (126 LPM)	24V	5A

Shurflo Automatic Bilge Float Switches



Constructed from ABS plastic, these non-mercury mechanical switches have a manual test feature and can be remote or direct mounted.

- 900mm (3ft) tinned power leads.
- Activates at 44mm / turns off at 19mm.
- Amp rating: 12A @ 12V / 6A @ 24V.
- Approvals: Ignition protected (ISO 8849), CE.

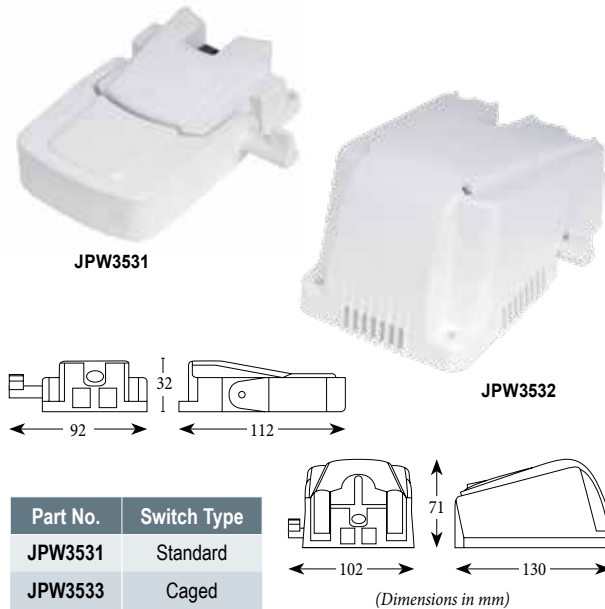

Shurflo AquaKing II Premium Freshwater Pumps - 4GPH



Automatic demand pumps with 4 independent chambers to deliver a smooth flow for up to 4 applications.

- Self-priming up to 1.8m (6ft).
- Dry run capability.
- Sealed switch and motor.
- Thermally protected.
- Adjustable by-pass and pressure switch.
- Includes 2x 1/2" hose barb fittings and inlet strainer.
- Approvals: Ignition protected (ISO 8849), CE.



Part No.	Flow Rate	Voltage	Amps	Shut-off Pressure
JPW3544	4 GPH (15 LPM)	12V	10A	55 PSI (3.8 BAR)
JPW3545	4 GPH (15 LPM)	24V	5A	55 PSI (3.8 BAR)

Shurflo AquaKing II Standard Freshwater Pumps - 3GPH



Featuring 4 independent chambers for up to 3 applications, these automatic demand pumps are quiet and can run dry without damage.

- Co-molded diaphragm.
- Self-priming up to 1.8m (6ft).
- Sealed switch and motor.
- Thermally protected.
- Adjustable by-pass and pressure switch.
- Corrosion resistant electro coated motor.
- Includes 2x 1/2" hose barb fittings.
- Requires inlet strainer.
- Approvals: Ignition protected (ISO 8849), CE.

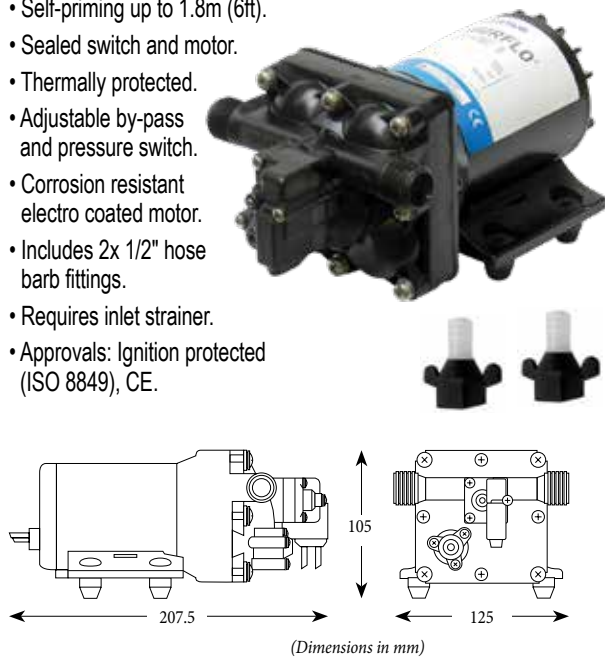

Part No.	Flow Rate	Voltage	Amps	Shut-off Pressure
JPW3541	3 GPH (12 LPM)	12V	6.5A	55 PSI (3.8 BAR)
JPW3542	3 GPH (12 LPM)	24V	3.8A	55 PSI (3.8 BAR)

Shurflo AquaKing II Supreme Freshwater Pumps - 5GPM



Automatic demand pumps with 4 independent chambers deliver a smooth flow for up to 4 applications.

- Co-molded diaphragm.
- Adjustable by-pass and pressure switch.
- Sealed switch and motor.
- Thermally protected.
- Dry run capability.
- Self-priming up to 1.8m (6ft).
- Corrosion resistant electro-coated motor.
- Includes 2x 1/2" hose barb fittings and inlet strainer.
- Approvals: Ignition protected (ISO 8849), CE.



Part No.	Flow Rate	Voltage	Amps	Shut-off Pressure
JPW3538	5 GPH (19 LPM)	12V	20A	55 PSI (3.8 BAR)
JPW3539	5 GPH (19 LPM)	24V	7.5A	55 PSI (3.8 BAR)

Shurflo Trail King II Freshwater Pump - 3GPH

A smaller unit designed mainly for RV/Caravan use, this freshwater pump features 4 independent chambers to deliver a smooth flow for up to 3 applications. This automatic demand pump is super quiet and can run dry without damage.

- Co-molded diaphragm.
- Self-priming up to 1.8m (6ft).
- Sealed switch and motor.
- Thermally protected.
- Adjustable by-pass and pressure switch.
- Corrosion resistant electro coated motor.
- Includes 2x 1/2" hose barb fittings.
- Requires inlet strainer.
- Approvals: Ignition protected (ISO 8849), CE.

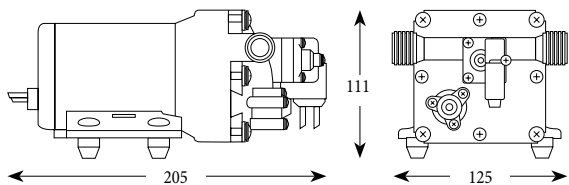

(Dimensions in mm)

Part No.	Shurflo MPN	Voltage	Amps	Shut-off Pressure
JPW3555	4009-101-B87	12V	5.3A	45 PSI (3.1 BAR)

Shurflo Pro Blaster II Deluxe Deckwash Pumps - 4GPM

Designed for intermittent duty only, these quiet automatic demand pumps can run dry without damage.

- 4 independent chambers.
- Co-molded diaphragm.
- Adjustable pressure switch.
- Self-priming up to 1.8m (6ft).
- Sealed switch and motor.
- Corrosion resistant electro-coated motor.
- Includes 2x 3/4" hose barb fittings, 1x 3/4" GHT fitting inlet strainer and spray nozzle.
- Approvals: Ignition protected (ISO 8849), CE.

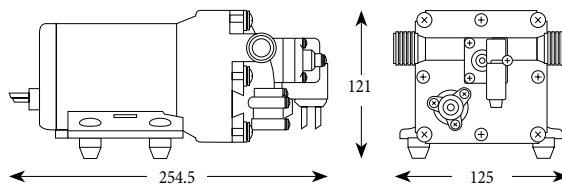

(Dimensions in mm)

Part No.	Shurflo MPN	Voltage	Amps	Shut-off Pressure
JPW3551	4248-153-E09	12V	10A	60 PSI (4.1 BAR)
JPW3552	4248-163-E09	24V	5A	60 PSI (4.1 BAR)

Shurflo Blaster II Deckwash Pump - 3.5GPM

Marine fresh or salt water wash-down installation, this pump may be also used for general water transfer.

- 4 independent chambers.
- Co-Molded diaphragm.
- Adjustable pressure switch.
- Self-priming up to 1.8m (6ft).
- Sealed switch and motor.
- Thermally protected.
- Corrosion resistance electro-coated motor.
- Includes 2x 3/4" hose barb fittings, 1x 3/4" GHT fitting and inlet strainer.
- Approvals: Ignition protected, CE.

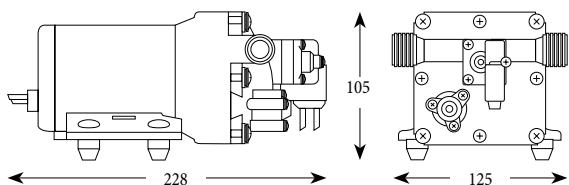

(Dimensions in mm)

Part No.	Shurflo MPN	Voltage	Amps	Shut-off Pressure
JPW3553	4238-121-E07	12V	7.5A	45 PSI (3.1 BAR)

Shurflo Pro Blaster II Ultimate Deckwash Pumps - 5GPM

Features 4 independent chambers to deliver a powerful consistent spray pattern to blast away grime on your deck.

- Co-molded diaphragm.
- Adjustable pressure switch.
- Self-priming up to 1.8m (6ft).
- Sealed switch and motor.
- Thermally protected.
- Dry run capability.
- Corrosion resistant electro coated motor.
- Includes 2x 3/4" hose barb fittings, 1x 3/4" GHT fitting, inlet strainer and spray nozzle.
- Approvals: Ignition protected (ISO 8849), CE.

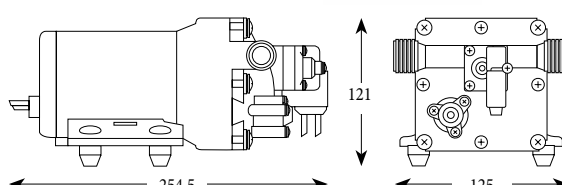

(Dimensions in mm)

Part No.	Shurflo MPN	Voltage	Amps	Shut-off Pressure
JPW3547	4258-153-E09	12V	14A	60 PSI (4.1 BAR)

Shurflo Pro Blaster II Deluxe & Ultimate Deckwash Pump Kits



Kits include:

- 1x Pro Blaster II Deckwash Pump (Deluxe 4GPH or Ultimate 5GPH).
- 1x Self-coil hose (25ft) with spray nozzle.
- 2x Straight swivel wing nut fittings.
- 2x Straight swivel adapter fittings.
- 1x Garden hose wing nut fitting.
- 1x Straight fitting.
- 1x Strainer.



Part No.	Shurflo MPN	Flow Rate	Volts	Amps
JPW3548	4348-153-E09	4 GPH (15 LPM)	12V	10A
JPW3549	4358-153-E09	5 GPH (19 LPM)	12V	14A

Shurflo Pro Baitmaster II Livewell Pump with Fittings - 4GPM



The seamless motor shell and sealed switch protects the pump from splashed liquids. Pump is self-priming and can run dry without damage.

- Corrosion resistant electro-coated motor.
- General water transfer.
- 4 independent chambers.
- Co-molded diaphragm.
- Adjustable pressure switch.
- For tank size 35 gallons and under.
- Includes 2x 3/4" hose barb fittings, 1x 3/4" GHT fitting and inlet strainer.
- Approvals: Thermally protected, Ignition protected, CE.

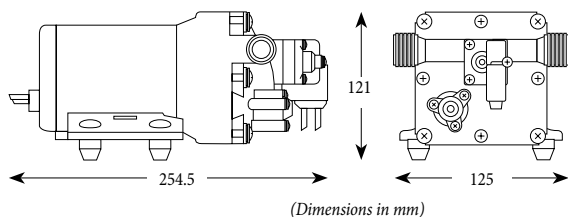

Part No.	Shurflo MPN	Voltage	Amps	Shut-off Pressure
JPW3535	4648-153-E07	12V	8A	45 PSI (3.1 BAR)

Shurflo Raw Water Strainers



High capacity strainers built to keep your bait tank, livewell and washdown pumps protected from harmful debris.

- Rugged nylon housing with clear twist-off polyamide bowl.
- Easy-to-clean slide out stainless steel screen.
- Includes an integral o-ring for a tight seal.



Part No.	Port Size
JPW3575	1/2"
JPW3576	3/4"
JPW3577	1"

Shurflo Water Strainers



Keep debris and other particles out of the pump with these clean economical strainers. Features a transparent clear bowl to easily see when the strainer needs cleaning.

- 50 mesh stainless steel screen.



Part No.	Inlet	Outlet	Outlet Type
JPW3561	1/2" Barb	1/2" NPSM	Twist-On
JPW3562	1/2" NPSM	1/2" NPSM	Twist-On
JPW3563	1/2" NPSM	1/2" Female	Swivel Nut

Shurflo Straight and Elbow 90° Fittings



- Nylon fittings with wingnut swivel.

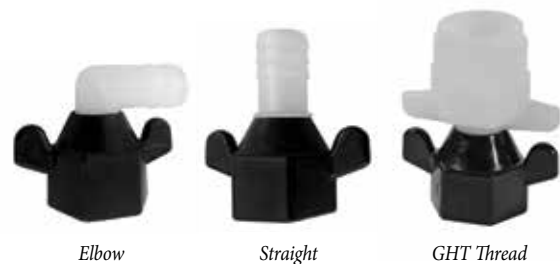

Part No.	Type	Inlet	Outlet
JPW3565	Straight	1/2" NPT	1/2" Barb
JPW3566	Straight	1/2" NPT	3/4" Barb
JPW3567	Elbow	1/2" NPT	1/2" Barb
JPW3568	Elbow	1/2" NPT	3/4" Barb
JPW3569	Straight	1/2" NPT	USA 3/4" GHT thread

Shurflo Accumulator Tank 1L



Bladder type pressure storage vessel and/or pulsation-dampening device designed to hold water under pressure.

- Smooths water faucet pulses and reduces pump cycling.
- Easily handles pressure requirements from 20 PSI to 125 PSI.
- Pre-Charge Pressure: 30 PSI.



Part No.	Dia x L (mm)
JPW3516	95 x 22

Waste Tank Carbon Filter Breather



Manufactured in light alloy and nylon, this filter must be installed in the highest possible location along the breather of the tank.

- 16mm (5/8"), 19mm (3/4") and 25mm (1") barbs.
- Carbon lifetime: approx. 1 year.



Part No.
JPW15893

Shurflo Drill Pump Kit



Attaching to any standard drill motor, this easy to use drill pump is ideal to pump water from appliances, aquariums, waterbeds, sinks, toilets, or drums.

- Not intended for use with flammable liquids, or in flammable environments.
- Self primes up to 8ft (vertical) / 25ft (horizontal).
- 1/4" Shaft fits standard drill.
- 3/4" male garden hose ports.
- Hoses included.



Part No.
JPW3519

Shurflo Waterguard In-line Drinking Water Filter



Two-stage water filter used to significantly reduce chlorine, taste, odor and sediment, providing crisp, clean and safe drinking water.

- Maximum inlet pressure 125 PSI (8.6 BAR).
- 13mm barbed hose connectors each end.
- Filters up to 22,700 litres of water.
- Wall/bulkhead mounting.



Part No.	Length (mm)	Diameter (mm)
JPW3574	279	65

Shurflo Self-Coiling Hose 7.6m



Blue spring coiled hose ideal for deck washdown use.

- Fitted with 3/4" (19mm) garden hose thread.



Part No.	Length	Diameter
JPW3558	7.6m (25ft)	13mm (1/2")

Hose Coil 7.6m

Blue polyurethane spring coiled hose ideal for deck wash-down use.



Part No.	Length
JPW1750	7.6m (25ft)

Wash Down Hose Kit 7.5 with Storage Housing

Complete horizontal mount hose storage and deck wash system.

- Includes white moulded storage housing, 7.6m (25ft) coiled hose with hose gun, deck wash hose connection, required fittings and hose clamps.



Part No.
JPW1751

Expandable Hoses with Spray Gun

Lightweight and easy to use revolutionary hose that expands and contracts automatically with water pressure.

- Polyester fabric cover with inner latex tube.
- Flexible hose avoids kinks, tangles or twists.
- High quality spray nozzle with 7 adjustable spray patterns.
- Includes durable and corrosion resistant brass connectors.



Part No.	Expanded Length (m)	Contracted Length (m)
JPW1753	7.6	2.5
JPW1754	15	5

Hose Coil Spray Gun

Designed for use with deck washdown pumps and features seven spray patterns including two shower settings as well as cone, mist, flat, soaker and jet.



Part No.
JPW1755

Cuffed Bilge Pump Hoses

Black plastic bilge pump discharge hose that has hose clamp cuffs every foot for easy hose clamping.



Part No.	Dia (mm)	Length (m)	Suits Rule Pumps (GPH)	Suits Jabsco Pumps (GPH)
JPW1730	20	15	360, 500, 800	380, 500, 700
JPW1731	28	15	1000, 1100, 1500, 2000	1500, 2000

Shurflo High Pressure Blaster Nozzle

Use with Shurflo Pumps or garden hose, this nozzle adjusts from a fine mist to full stream with a lock clip for continuous spray.

- High impact plastic for long life.



Part No.	Connection
JPW3570	3/4" [19mm] Garden Hose Thread

Cuffed Bilge Pump Hose Kits

Submersible bilge pump plumbing installation kits.

- Includes cuffed hose, nylon skin fitting and two stainless steel hose clamps.



Part No.	Dia (mm)	Length (m)
JPW2696	20	1.5
JPW2697	28	1.8

Multi-Purpose Clear Hoses

Premium quality clear multi-purpose hose suitable for air, water and mild chemical applications.

- Conforms to AS2070 (plastics for food contact) making it suitable for general food applications.
- Conforms to AS2554 and has moderate level of UV protection.
- Not suitable for permanent fuel lines.
- Sold in pre-cut 20m rolls or ordered in cut to metre lengths.

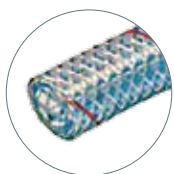

Part No.		Dia (mm)
20m Roll	Cut to Length	
JPW1741	-	12
JPW1742	-	20
JPW1743	-	25
JPW1744	JPW1744C	32
JPW1745	JPW1745C	38
JPW1747	JPW1747C	50

MarineFlex Bilge Hoses

A smooth bore lightweight hose with excellent flexibility. Particularly well suited for suction lines on bilge pumps, toilet installations and other applications requiring tight bends.

- Excellent UV stability.
- Conforms to AS2070 (plastics for food contact).
- Not suitable for use with fuels or drinking water.
- Operating temperature from -5°C to +60°C



Part No.	I.D. (mm)	I.D. (in)	O.D. (mm)	Length (m)
JPW1720	20	3/4	24.5	20
JPW1721	25	1	31.9	20
JPW1722	28	1 1/8	34	20
JPW1723	32	1 1/4	39.4	20
JPW1724	38	1 1/2	46.1	20

Premium Bilge Hoses

A premium version of the Marine-Flex manufactured with a smooth outer, to assist in the placement of hose clamps. Its thicker wall means greater strength and in service life.



Part No.	I.D. (mm)	I.D. (in)	O.D. (mm)	Length (m)
JPW1732	20	3/4	24	20
JPW1733	28	1 1/8	34.9	20



Sanitation Hoses

Heavy duty white suction hose specifically made for marine toilet installations. Its nitrile content (greater than 15%) provides excellent resistance against odour permeation in toilet applications.

- Smooth bore lightweight hose with excellent flexibility for waste applications.



Part No.		Dimensions (mm)	
20m Roll	Cut to Length	I.D.	O.D.
JPW1760	JPW1760C	20	25.8
JPW1761	JPW1761C	25	31.9
JPW1762	JPW1762C	38	46.1

Marine Exhaust Hoses

Lightweight corrugated hose with excellent flexibility for conveying wet exhaust fumes. Lloyds approved. Lloyds No. 08/1006 (E2).

- Cover: Corrugated cover. Black with blue stripe. Synthetic (corrugated finish). Ozone and oil resistant and flame resistant.
- Reinforcement: high tensile textile cords with embedded steel helix wires.
- Tube: NBR blend handles 40% aromatics.
- Temperature Range: -20° C to 121° C
- Working Pressure: 5 Bar 3:1 safety factor
- Sold in pre-cut 20m rolls or ordered in cut to metre lengths.



Part No.		I.D. (mm)	I.D. (in)	Bend Radius (mm)
Cut to Length	20m Roll			
JPW1788	JPW1789	38	1 1/2	229
JPW1790	JPW1791	45	1 3/4	261
JPW1792	JPW1793	50	2	406
JPW1794	JPW1795	63	2 1/2	508
JPW1796	JPW1797	76	3	610
JPW1798	-	90	3 1/2	711

Marine Fuel Line Hoses

Recommended for fuel feed and vent applications on marine pleasure crafts. This hose exceeds U.S. Coast Guard requirements for type A1 service as outlined in SAE J1527.

- Suitable for below deck or permanent applications.



Part No.	I.D. (mm)	I.D. (in)	O.D. (mm)	Length (m)
JPW1774	8	5/16	18	30
JPW1776	10	3/8	19.8	30
JPW1778	12	1/2	22.8	30
JPW1780	16	5/8	25.8	30

Outboard Fuel Hoses

Reinforced fuel hose suitable for outboard fuel lines and portable or above deck mounted tanks.

- Do not use for below deck or permanent applications.



Part No.	I.D. (mm)	I.D. (in)	Length (m)
JPW2501	8	5/16	20
JPW2502	10	3/8	20

Marine Fuel Filler Hoses

Type A2 fuel fill hose constructed with high-grade chemigum tube for superior fuel resistance for type A2 fuel fill applications. This is the connection from the boats fuel tanks to the filler cap.

- Flame retardant cover.
- Two-ply synthetic braid with wire helix.
- Black nitrile tube.
- Temperature range: -30° to 90° C.
- Sold as a 15m coil or per metre.



Part No.		I.D. (mm)	I.D. (in)	O.D. (mm)
Cut to Length	15m Roll			
JPW1782	JPW1784	38	1 1/2	47.1
JPW1785	JPW1787	51	2	61.5

Standard Stainless Steel Hose Clamps

Australian-made 316-grade stainless steel perforated band worm drive hose clamps

- Sold per box quantity 10x clamps.



Part No.	Clamp No.	Min-Max (mm)	Band Width (mm)
JPW2000	MAH004P	6-16	8
JPW2001	MAH006P	11-22	8
JPW2002	HAS008P	13-25	12.7
JPW2003	HAS010P	14-27	12.7
JPW2008	HAS012P	18-32	12.7
JPW2009	HAS016P	21-38	12.7
JPW2004	HAS020P	21-44	12.7
JPW2005	HAS024P	27-51	12.7
JPW2006	HAS028P	33-57	12.7
JPW2014	MAH028P	33-57	8
JPW2007	HAS032P	40-64	12.7
JPW2013	HAS052P	71-95	12.7

T-Bolt Stainless Hose Clamps

Australian-made 304-grade stainless steel T-bolt hose clamps for extra heavy duty applications where large tightening forces are required.

- Solid band with a rolled edge
- Tightened via a high-tensile 316-grade stainless hex head bolt.
- Extra solid construction with easy installation and tightening.
- Sold per box.



Part No.	Clamp No.	Min-Max (mm)	Band Width (mm)	Box Qty
JPW2050	TTBS40-43P	40-43	20	10
JPW2051	TTBS44-47P	44-47	20	10
JPW2052	TTBS48-51P	48-51	20	10
JPW2053	TTBS52-55P	52-55	20	10
JPW2054	TTBS56-59P	56-59	20	10
JPW2055	TTBS60-63P	60-63	20	10
JPW2056	TTBS64-67P	64-67	24	10
JPW2057	TTBS71-76P	71-76	24	10
JPW2058	TTBS77-82P	77-82	24	10
JPW2059	TTBS83-88P	83-88	24	10
JPW2060	TTBS89-94P	89-94	24	10
JPW2061	TTBS95-100P	95-100	24	10
JPW2062	TTBS101-107P	101-107	24	10
JPW2063	TTBS108-116P	108-116	24	10
JPW2064	TTBS117-125P	117-125	24	10
JPW2065	TTBS126-134P	126-134	24	10
JPW2066	TTBS140-148P	140-148	26	10
JPW2067	TTBS149-161P	149-161	26	5
JPW2068	TTBS162-174P	162-174	26	5

Hose Clamps with Safety Collar

Australian-made 304-grade stainless steel solid band hose clamps.

- Feature a removable blue safety collar to prevent screwdriver slip.
- Sold per box quantity 10x clamps.



Part No.	Clamp No.	Min-Max (mm)	Band Width (mm)
JPW2020	SMPC000P	9-12	9
JPW2021	SMPCM00P	11-16	9
JPW2022	SMPC00P	13-20	9
JPW2023	SMPC0AP	16-24	12.7
JPW2024	SMPC0P	16-27	12.7
JPW2025	SMPC1AP	22-32	12.7
JPW2026	SMPC1P	22-38	12.7
JPW2027	SMPC1XP	30-42	12.7
JPW2028	SMPC2AP	35-48	12.7
JPW2029	SMPC2P	35-53	12.7
JPW2030	SMPC2XP	40-57	12.7
JPW2031	SMPC3P	52-70	12.7
JPW2032	SMPC4P	65-90	12.7
JPW2034	SMPC5P	85-110	12.7
JPW2035	SMPC6P	105-130	12.7
JPW2036	SMPC7P	130-155	12.7
JPW2037	SMPC8P	155-180	12.7
JPW2038	SMPC9	180-205	12.7

KALE W4 Stainless Hose Clamps

Part No.	Min-Max (mm)	Band Width (mm)
JPW1971	8-12	9
JPW1972	8-16	9
JPW1973	12-20	9
JPW1974	12-22	9
JPW1975	16-27	12
JPW1976	20-32	12
JPW1977	23-35	12
JPW1978	25-40	12
JPW1979	30-45	12
JPW1980	32-50	12
JPW1981	40-60	12
JPW1982	50-70	12
JPW1983	60-80	12
JPW1984	70-90	12
JPW1985	80-100	12
JPW1986	90-110	12
JPW1987	100-120	12
JPW1988	110-130	12
JPW1989	120-140	12
JPW1990	130-150	12
JPW1991	140-160	12

Superior hose clamps, German designed and European made, all parts manufactured from 304-grade stainless steel.

- High clamping force with low tightening torque.
- Burr-free and convex band edges.
- Sold per box quantity 10x clamps.



Skin Fittings Nylon Body Stainless Steel Cap - Straight

Made from high-strength nylon plastic bodies. Includes non-corrosive, highly polished 316-grade stainless steel cap.

- Install above water line only.

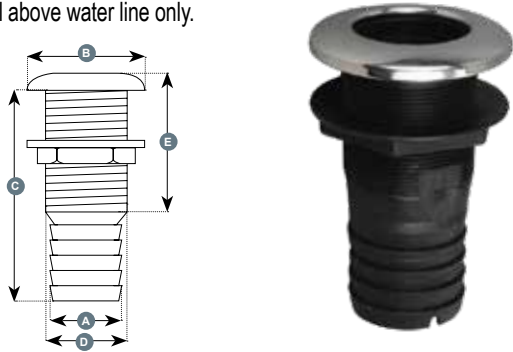

Part No.	A		B (mm)	C (mm)	D (mm)	E (mm)
	(mm)	(in)				
JPW1830	19	3/4	48	80	38.28	50
JPW1831	25	1	48	80	38.28	50
JPW1832	28	1 1/8	48	80	38.28	50
JPW1834	38	1 1/2	60	95	40.40	50

Skin Fittings Nylon Body Stainless Steel Cap - 90 degree

Made from high-strength nylon plastic bodies. Includes non-corrosive, highly polished 316-grade stainless steel cap.

- Suitable for installation above water line only.

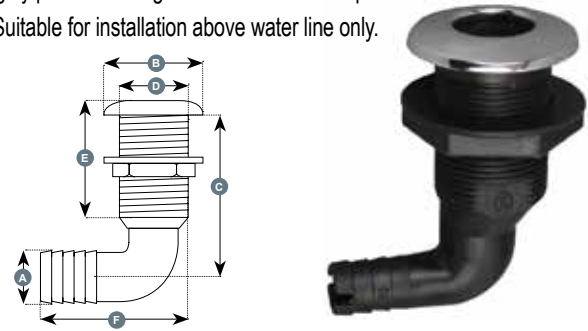

Part No.	A		B (mm)	C (mm)	D (mm)	E (mm)	F (mm)
	(mm)	(in)					
JPW1837	19	3/4"	48	73.4	33.4	50	64.3
JPW1838	25	1"	48	75	33.4	50	64.3
JPW1839	28	1 1/8"	48	75	33.4	50	91.2
JPW1841	38	1 1/2"	60	88	40.4	50	91.2

Skin Fittings 316 Stainless BSP Thread

Skin fitting with BSP thread to screw directly into a valve. Cast 316-grade stainless steel with lock nut washer included.



Part No	Thread BSP (in)	A (mm)	A1 (mm)	H (mm)	D (mm)
JPW1843	1/2	39	15	61	21
JPW1844	3/4	49	19	70	26.5
JPW1845	1	54	25	72	33.3
JPW1846	1 1/4	63	34	78	42
JPW1847	1 1/2	70	38	79	47.5
JPW1848	2	84	51	95	59.5

Skin Fittings 316 Stainless Hose Tail

Skin fitting with hose tail end to connect directly to hose. Cast 316-grade stainless steel with lock nut washer included.

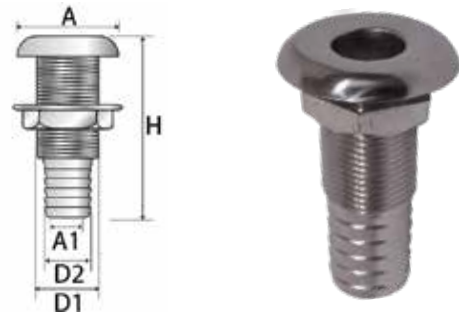

Part No	Thread BSP (in)	A (mm)	A1 (mm)	H (mm)	D1 (mm)	D2 (mm)
JPW1858	3/8	36	7.5	57.5	20.5	12
JPW1859	1/2	38.5	20	62	27	19
JPW1860	3/4	50	24.6	74	34.5	25
JPW1864	3/4	50	24.6	74	34.5	28
JPW1861	1	55	32.7	80	42	32.6
JPW1862	1 1/4	64	40	83.3	50	38.6
JPW1863	1 1/2	84	47	99.5	34.5	52

Thru-Hull Nylon Pickup

Nylon thru-hull pickup with BSP male thread.

- Suits a ball valve with 25mm (1") female thread.
- Thread length: 65mm.



Part No.	Cut-Out Hole (mm)
JPW1807	25

Transom Well Drain

White nylon fine threaded drain with push-on grip flanged end fitting.

- Can be used for draining motor or anchor wells.



Part No.	Total Length (mm)	Cut Out Hole (mm)
JPW5420	55	25

Nylon Skin Fittings

High quality Australian made white nylon skin fittings with a tapered outer head to lower drag.

- Dual connection with barbed tail for hose and a BSP male thread.
- **JPW1801** has a dual sized barbed tail.



Part No.	Hose Size		Mount Hole (mm)	Length (mm)
	(in)	(mm)		
JPW1801	1/2" & 5/8"	12 & 16	20	68
JPW1802	3/4"	19	25	81
JPW1803	1"	25	32	81
JPW1804	1 1/4"	32	40	81
JPW1805	1 1/2"	38	46	82
JPW1806	1 1/8"	28	32	95

Polypropylene Skin Fitting

Thru hull skin fitting made from polypropylene.

- Barbed hose tail can be cut off and male BSP threaded connection can screw into valve if desired.



Part No.	Hose Size		Mount Hole (mm)	Length (mm)
	(in)	(mm)		
JPW1808	1 1/2"	38	47	96

Non-Return Valve - Dual Size

Australian-made premium one-way valve, suitable for galley pumps.

- Stepped ports.



Part No.	Hose Size (mm)
JPW1816	12 & 20

Shurflo Non-Return In-Line Check Valve

One direction valve safeguards against backsurge up to 100 PSI.



Part No.	Hose Size
JPW3572	13mm (1/2")

Non-Return Valve - Dual Size

Dual size to suit two different hose sizes.

- Made from reinforced nylon with neoprene valves and stainless steel fasteners.



Part No.	Hose Size (mm)
JPW1817	25 & 38

Scupper Valve with Rubber Flap 70mm

White nylon material with rubber flap valve that opens to let water out then seals back to prevent water entering.

- Supplied with stainless steel screws.



Part No.	O.D (mm)	I.D (mm)
JPW1827	70	48

Thru-Tansom Scupper

White nylon material with rubber flap valve that opens to let water out, then seals back to prevent water entering.

- Designed to pass through a bulk head.



Part No.	Hose Size		Length (mm)
	(in)	(mm)	
JPW1828	1 1/2"	38	152

Acetal Hose Connectors (Hose Tail)

Made from extra strong chemically resistant acetal resin, offering superior performance in many applications from fuel lines to water outlets.



Part No.	Hose Size		Thread BSP (in)	Length (mm)
	(in)	(mm)		
JPW1810	1/2	13	1/2	67
JPW1811	5/8	16	5/8	67
JPW1812	3/4	19	3/4	80
JPW1813	1	25	1	80
JPW1814	1 1/4	32	1 1/4	80
JPW1815	1 1/2	38	1 1/2	83

Ball Valves - Stainless Steel

Two piece, lever operated ball valve. Made from marine grade 316-grade stainless steel with stainless steel ball, stem and handle.

- BSP threaded ports.



Part No	Size	
	(in)	(mm)
JPW1874	3/4	19
JPW1875	1	25

Vented Loops

For inlet and discharge pipes of manual and electric toilets installed below the waterline.

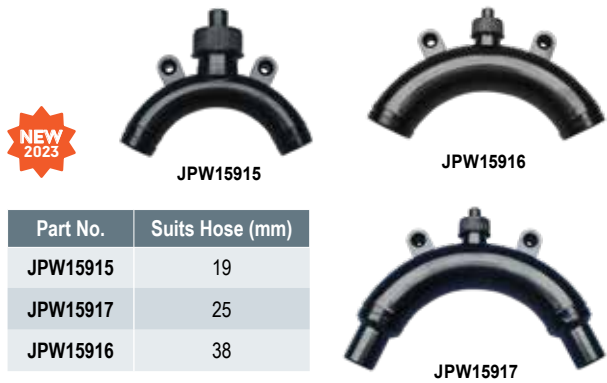

Part No.	Suits Hose (mm)
JPW15915	19
JPW15917	25
JPW15916	38

Y Valve 38mm

A universal valve to discharge either overboard or into waste tanks designed for long distance control by means of a push-pull cable.

- Orientable port connections: 38 mm.
- Can be operated through bulkhead.
- Equipped with extra 25 mm straight inlet port and handle extension.
- Padlockable.



Part No.
JPW15918

Stainless Steel Sinks

304-grade stainless steel with semi-gloss or mirror polished finish.

- 90° support edge.
- Includes 1 1/4" waste and plug.

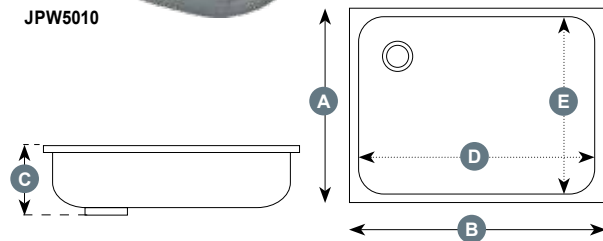

Part No.	Sink Shape	Finish	Dimensions (mm)				
			A	B	C	D	E
JPW5006	Rectangle	Semi-gloss	320	260	150	300	340
JPW5007	Rectangle	Semi-gloss	355	260	150	335	240
JPW5010	Oval	Mirror Polish	265	382	130	356	240
JPW5011	Round	Mirror Polish	285	285	180	260	260

Sink Waste and Plugs - 1" (25mm)

- To suit stainless steel sinks above.



Part No.	Type	Hose Tail (mm)	Plug Size (mm)	Hole Cut-Out Size (mm)
JPW5016	Straight	28	25	32
JPW5017	90°	28	25	32
JPW5012	Straight Waste & 25mm Plug Set			
JPW5018	Plug Only 25mm (1") Ø			

